

**LEGEND**

# STUDY INTERSECTION

##(##) AM(PM) PEAK HOUR VOLUME

FIGURE 1A

2021 EXISTING  
COUNT DATA (MAY)  
AM & PM PEAK HOUR

**BOE** Consulting Services, LLC

9901 Brodie Lane 160-303  
Austin, Texas 78748  
Tel. (512) 632-7509  
TBPE Registration Number F-19220



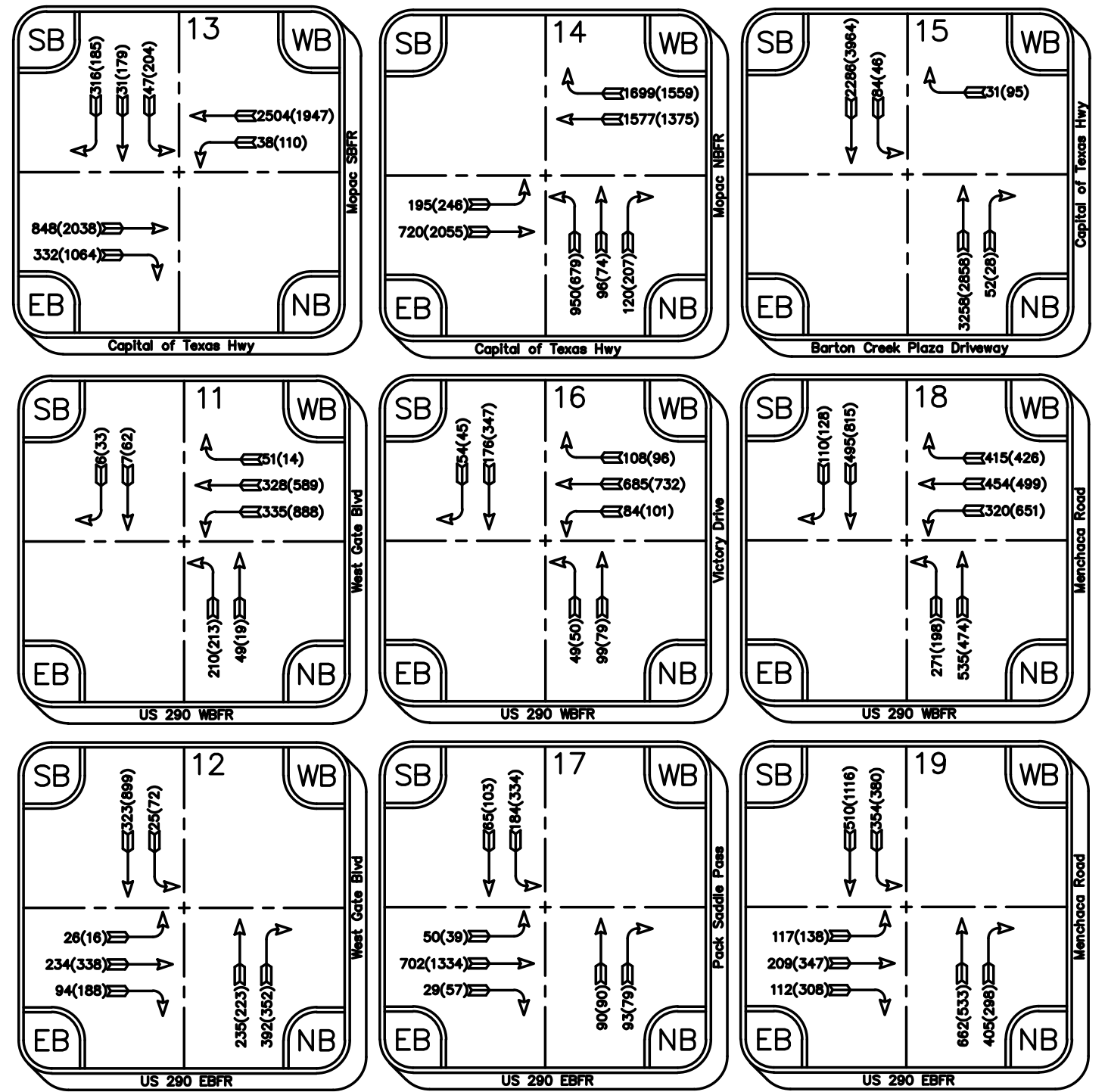
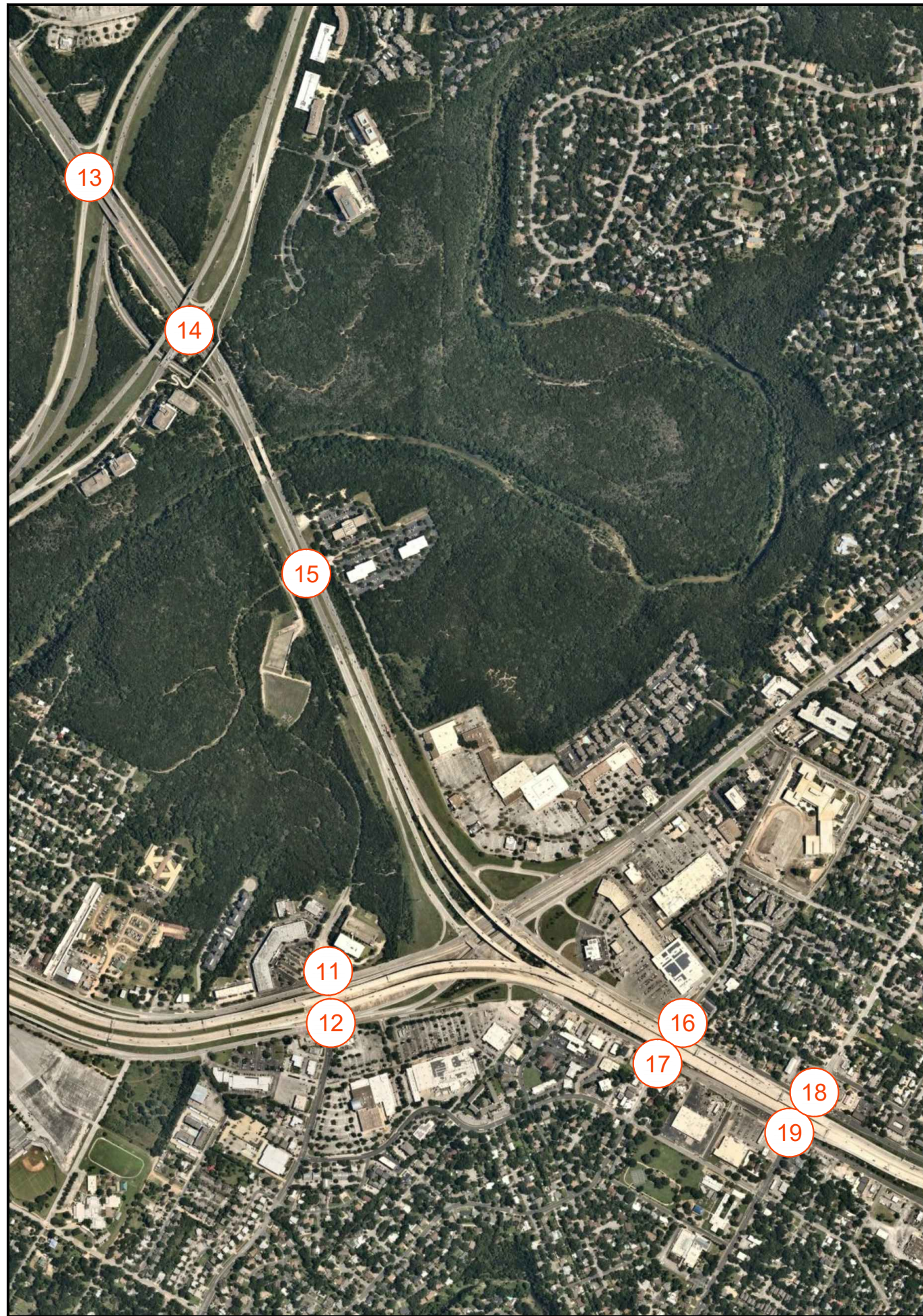

**LEGEND**  
 # STUDY INTERSECTION  
 ##(##) AM(PM) PEAK HOUR VOLUME

FIGURE 1A  
 2021 EXISTING  
 COUNT DATA (MAY)  
 AM & PM PEAK HOUR  
**BOE** Consulting  
 Services, LLC  
 9901 Brodie Lane 160-303  
 Austin, Texas 78748  
 Tel. (512) 632-7509  
 TBPE Registration Number F-19220



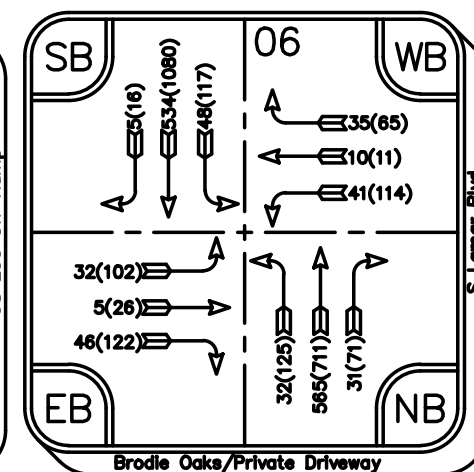
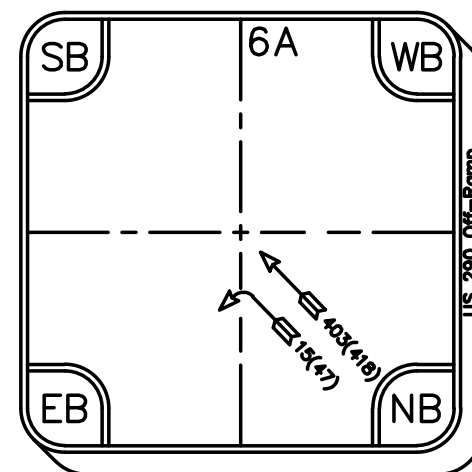
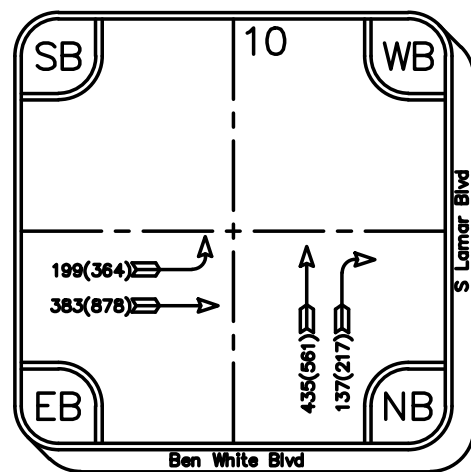
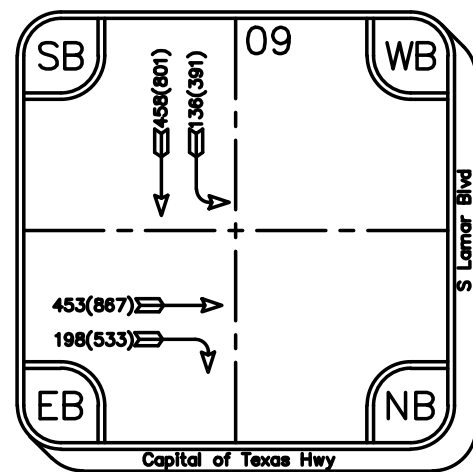
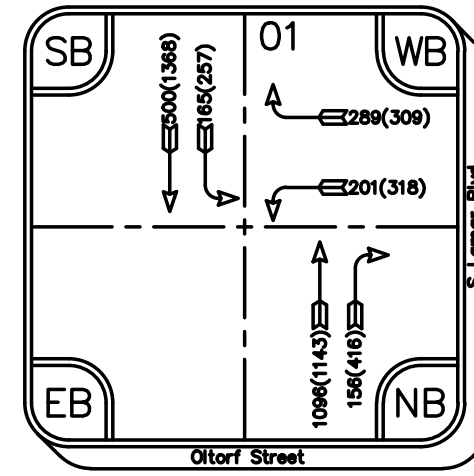
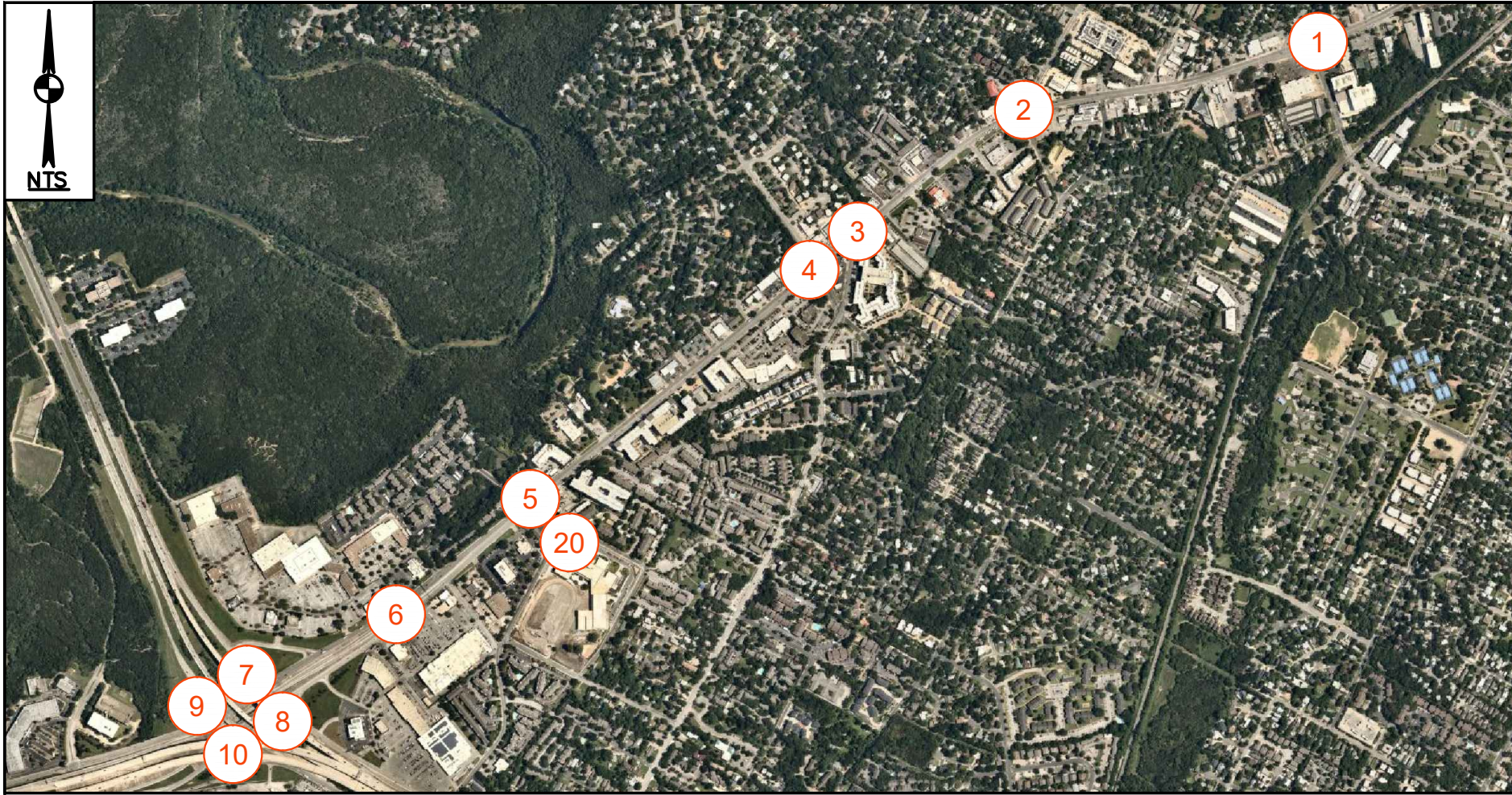

**LEGEND**  
 # STUDY INTERSECTION  
 ##(##) AM(PM) PEAK HOUR VOLUME

FIGURE 1B  
 2021 EXISTING  
 COUNT DATA (JUNE)  
 AM & PM PEAK HOUR  
**BOE** Consulting Services, LLC  
 9901 Brodie Lane 160-303  
 Austin, Texas 78748  
 Tel. (512) 632-7509  
 TBPE Registration Number F-19220



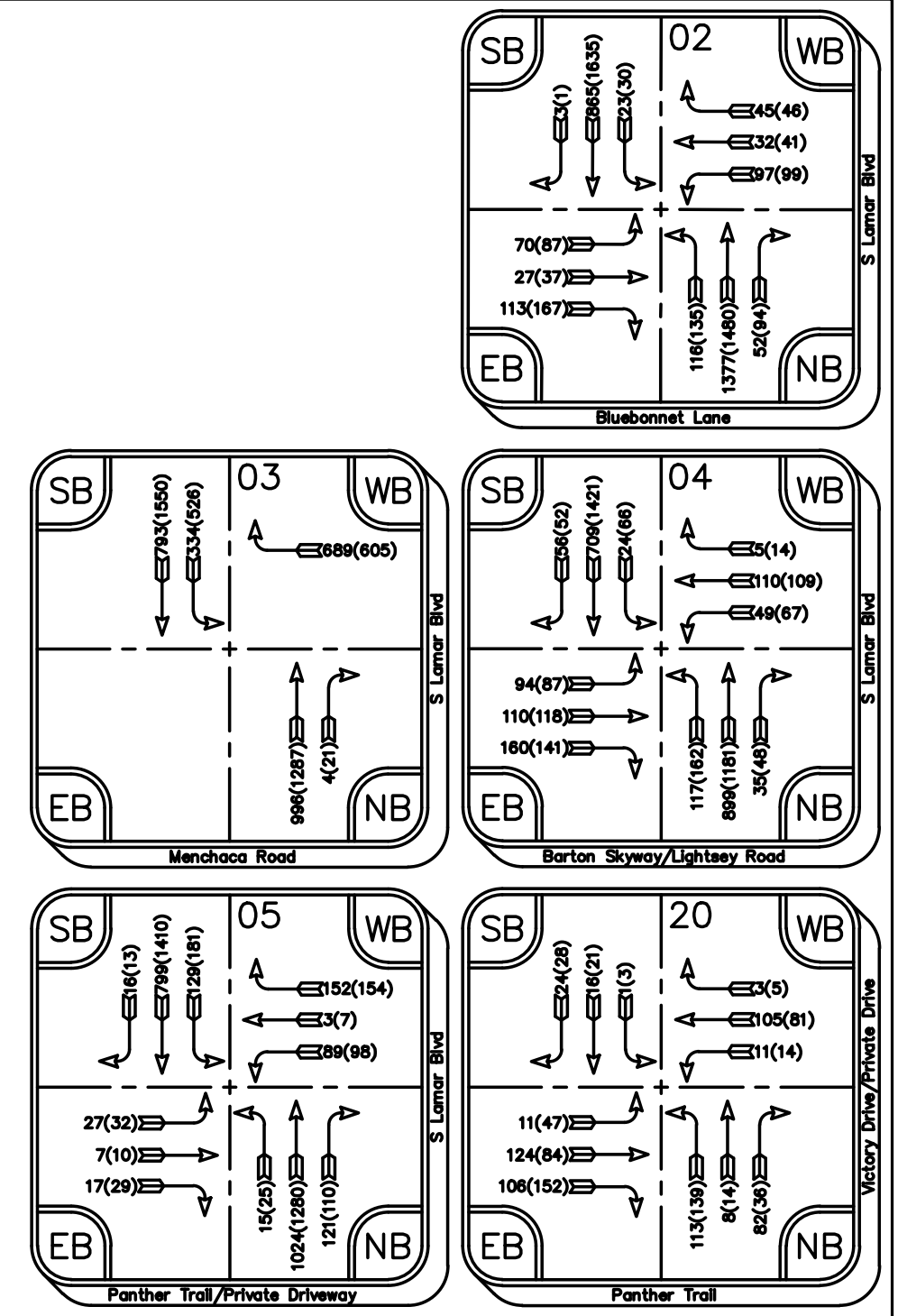
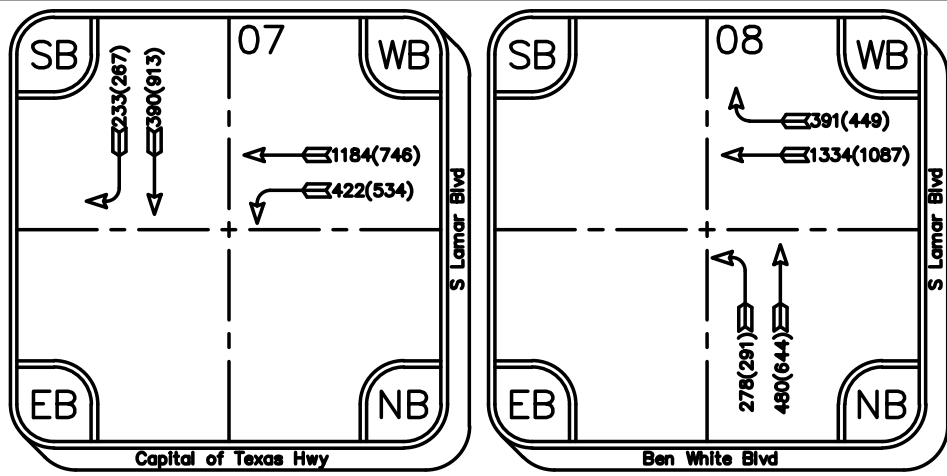
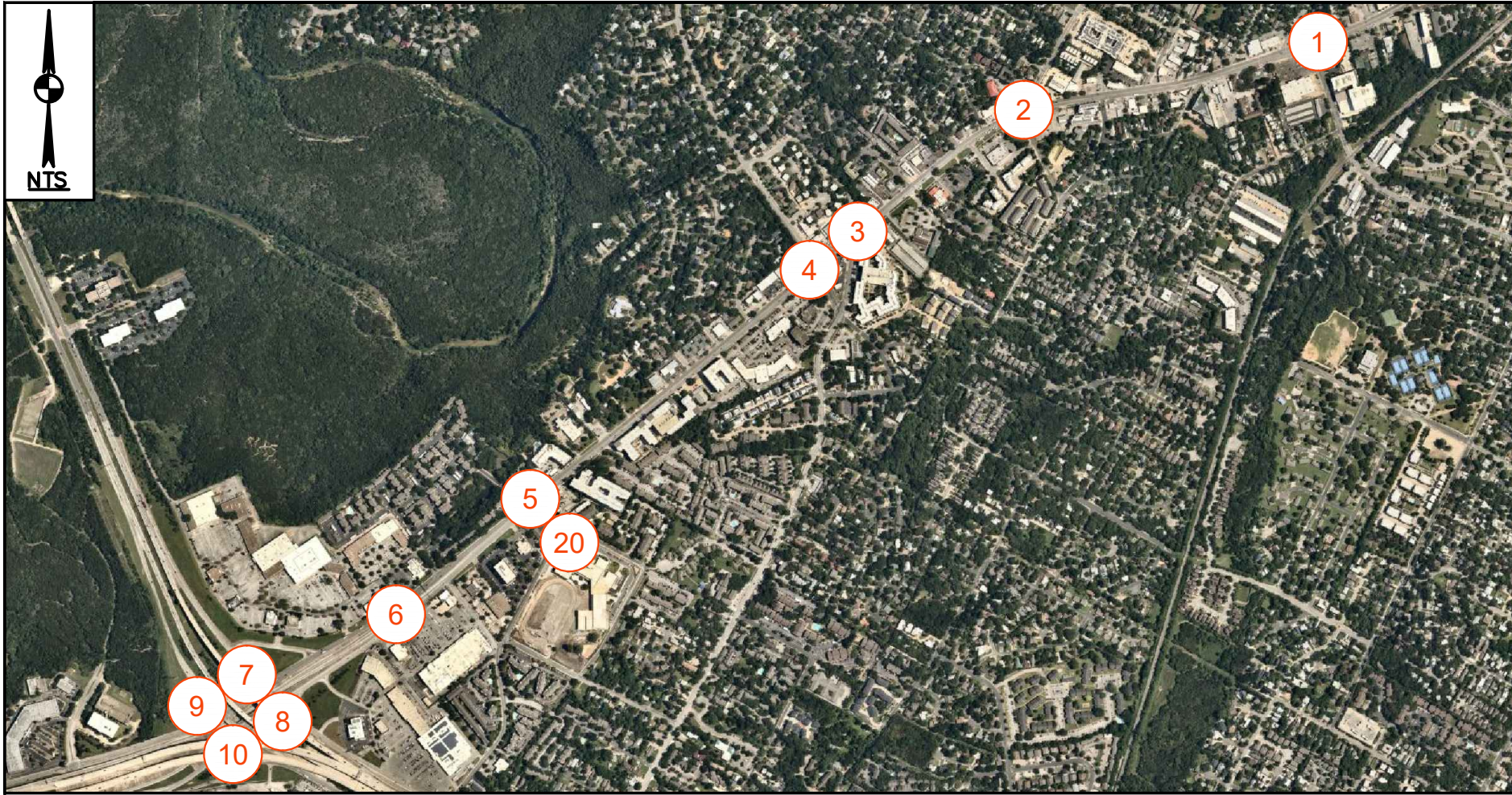

**LEGEND**

# STUDY INTERSECTION

##(##) AM(PM) PEAK HOUR VOLUME

FIGURE 1C

2021 EXISTING (MAY)  
PANDEMIC-ADJUSTED  
AM & PM PEAK HOUR



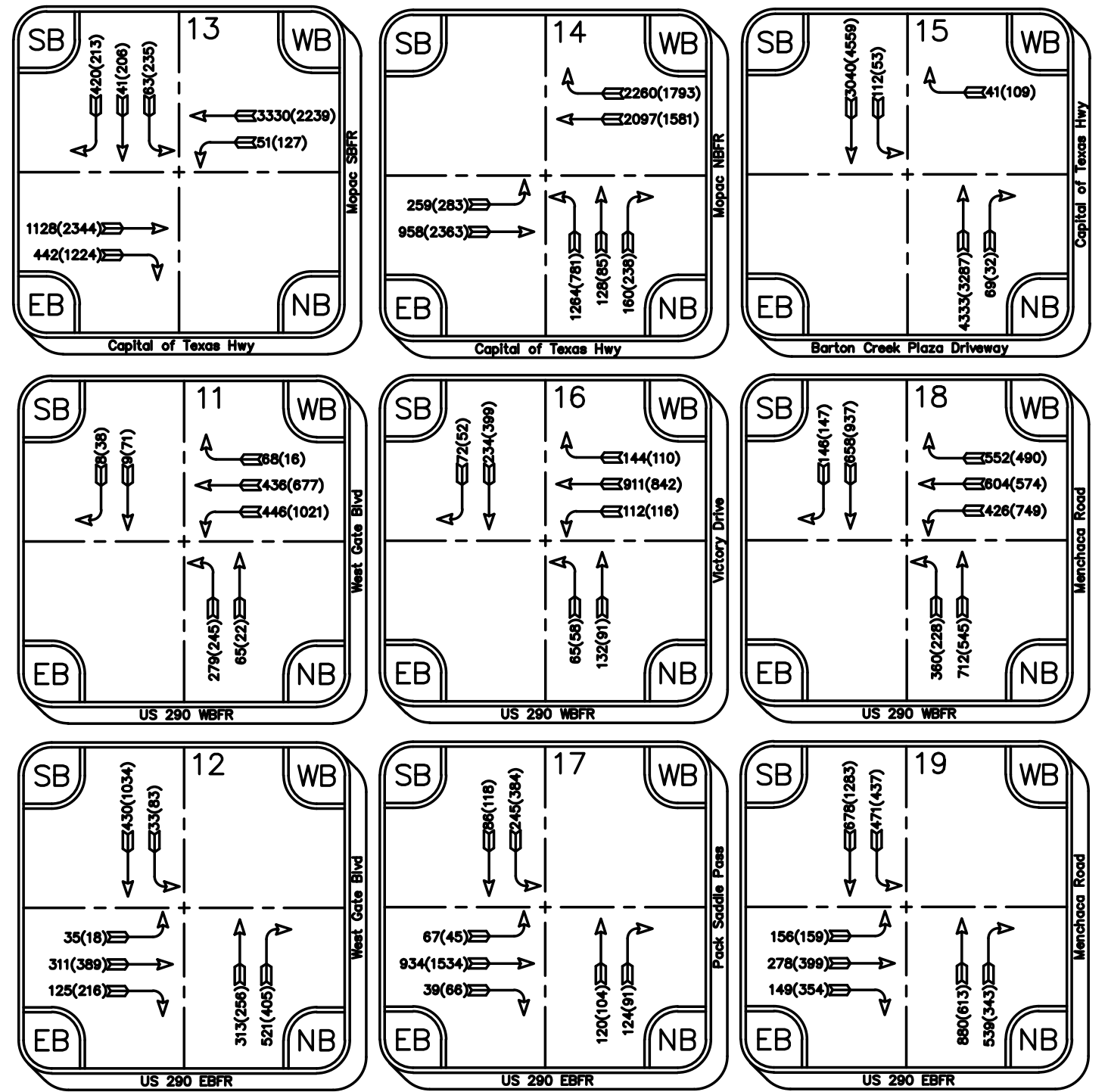
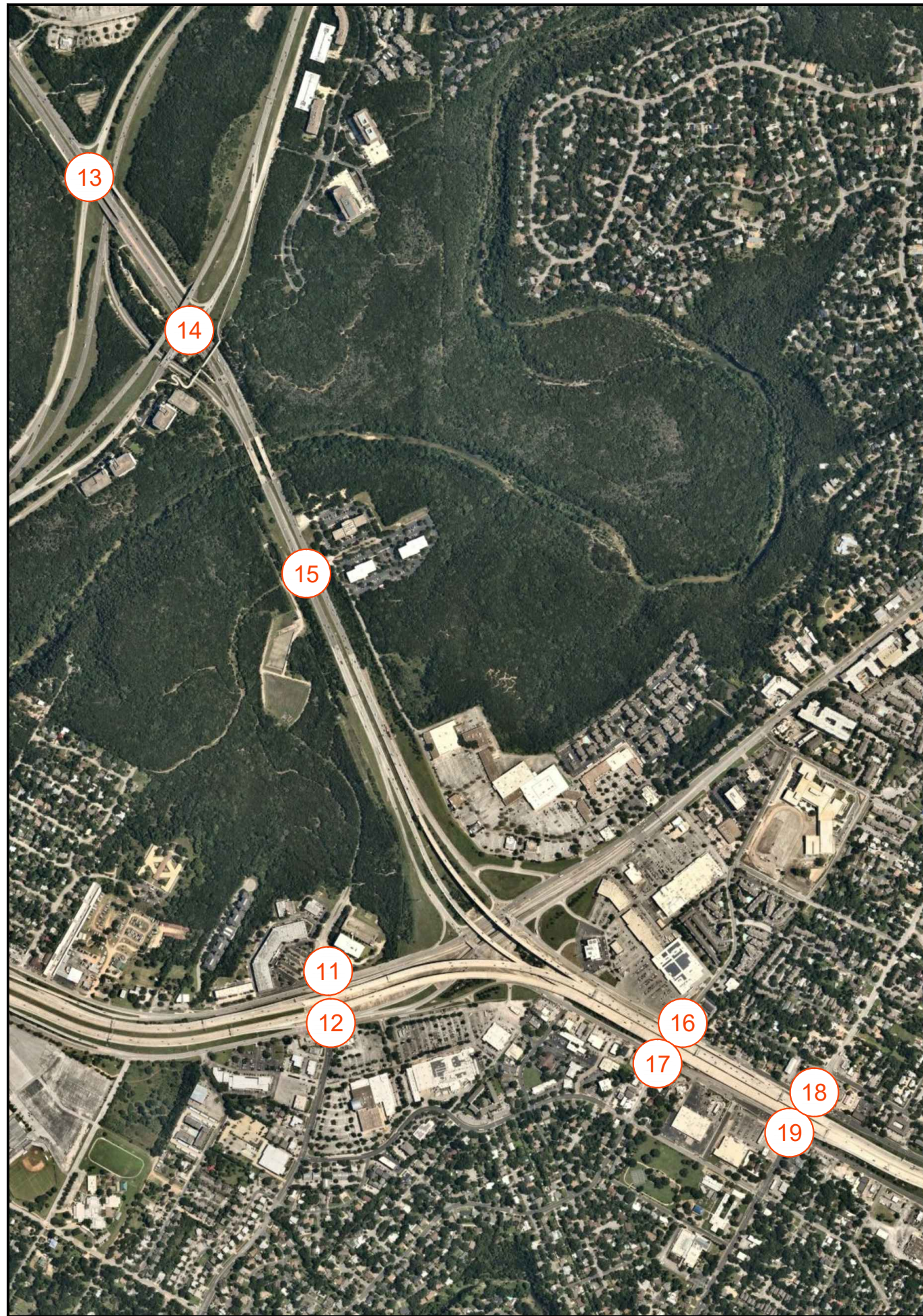

**LEGEND**  
 # STUDY INTERSECTION  
 ##(##) AM(PM) PEAK HOUR VOLUME

FIGURE 1C  
 2021 EXISTING (MAY)  
 PANDEMIC-ADJUSTED  
 AM & PM PEAK HOUR

**BOE** Consulting Services, LLC  
 9901 Brodie Lane 160-303  
 Austin, Texas 78748  
 Tel. (512) 632-7509  
 TBPE Registration Number F-19220



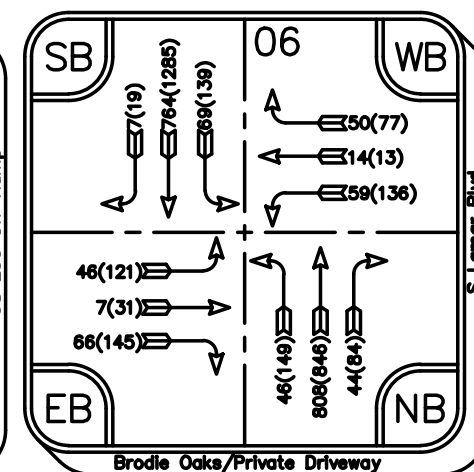
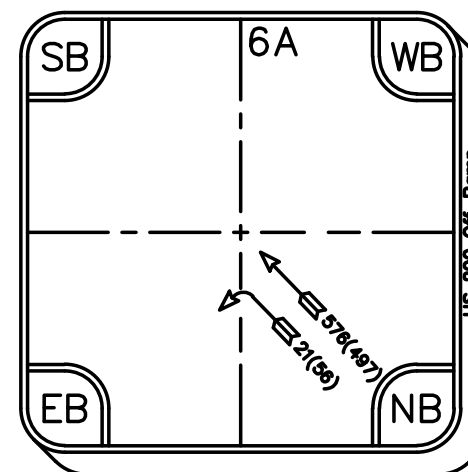
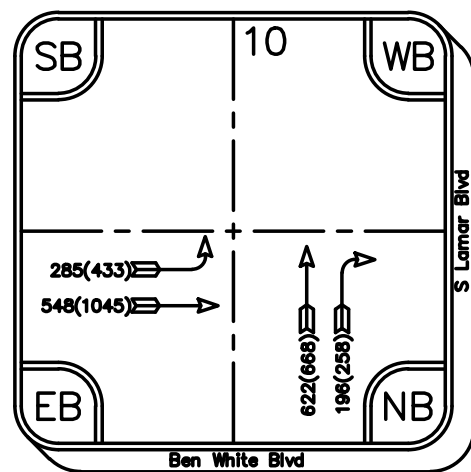
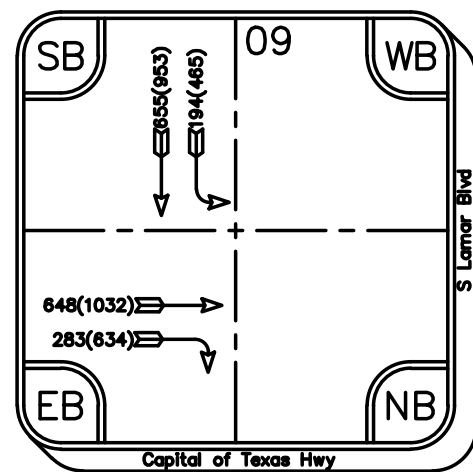
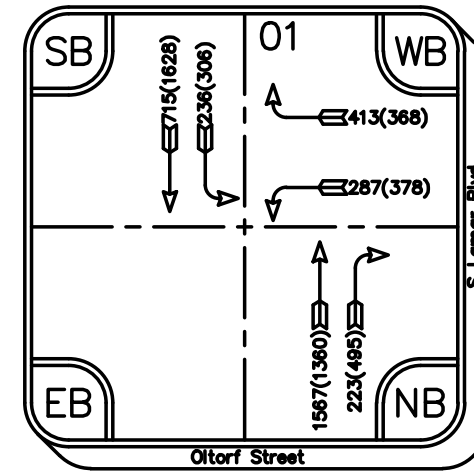
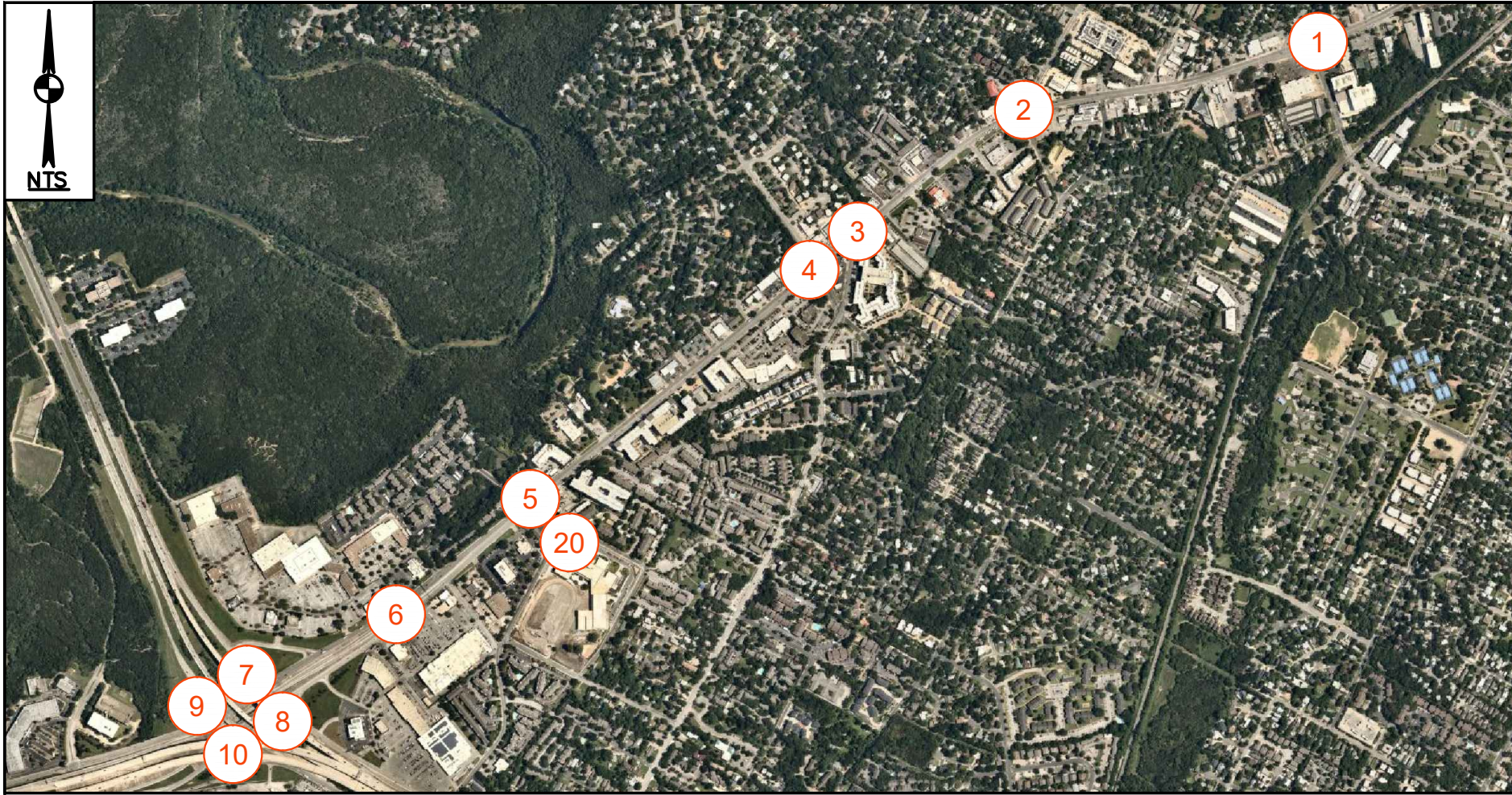

**LEGEND**  
 # STUDY INTERSECTION  
 ##(##) AM(PM) PEAK HOUR VOLUME

FIGURE 1D  
 2021 EXISTING (JUNE)  
 PANDEMIC & SCHOOL - ADJUSTED  
 AM & PM PEAK HOUR

**BOE** Consulting Services, LLC  
 9901 Brodie Lane 160-303  
 Austin, Texas 78748  
 Tel. (512) 632-7509  
 TBPE Registration Number F-19220



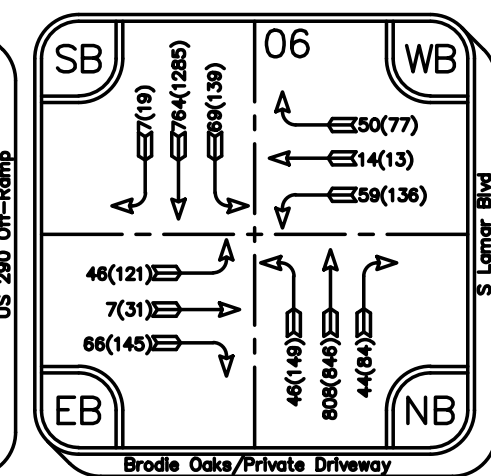
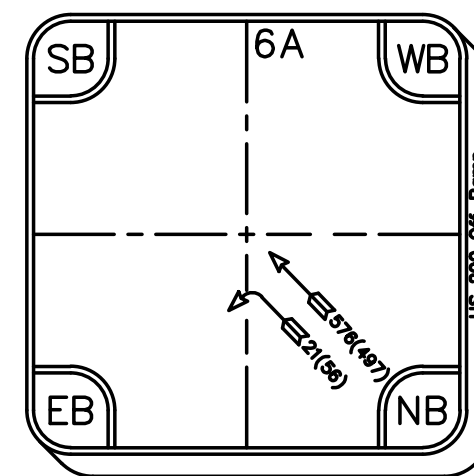
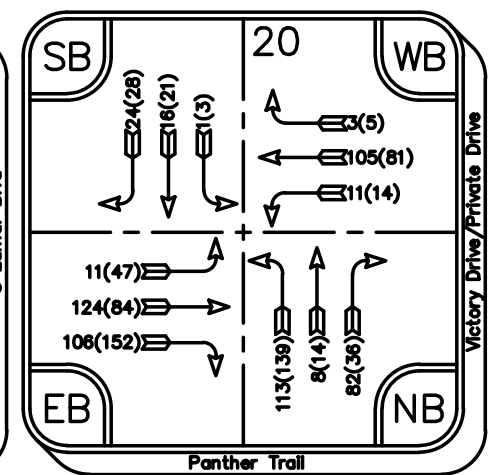
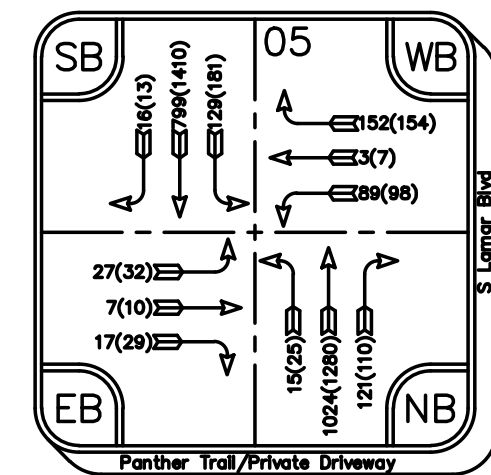
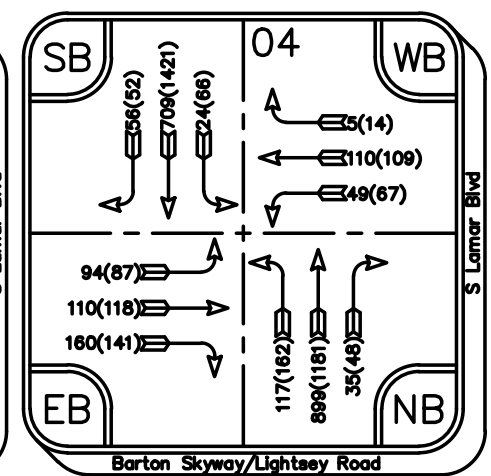
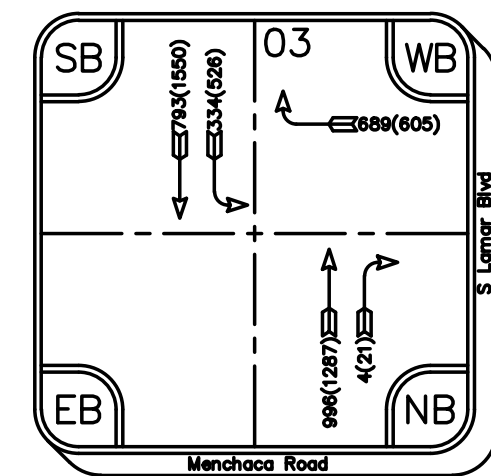
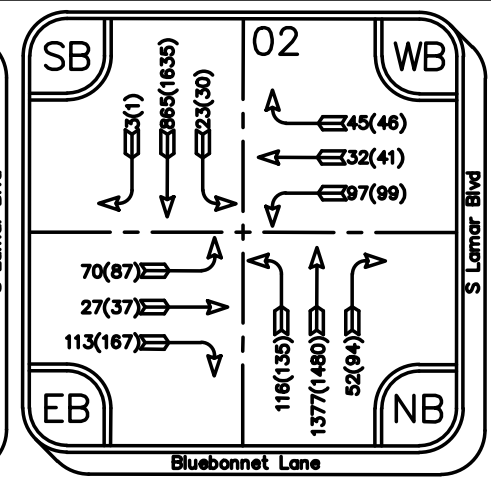
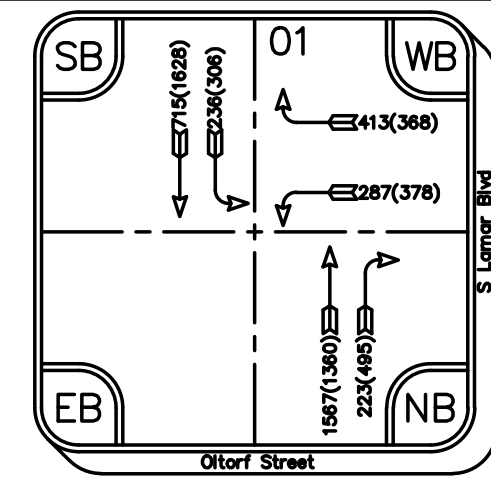
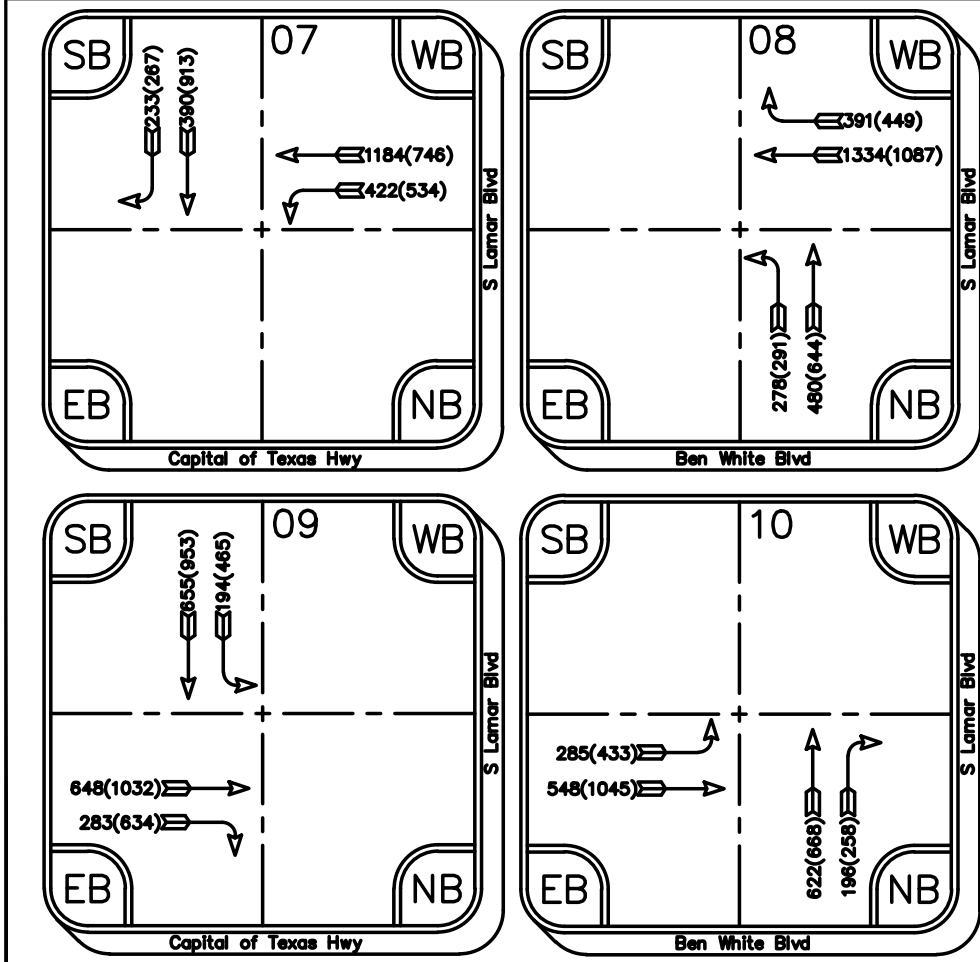
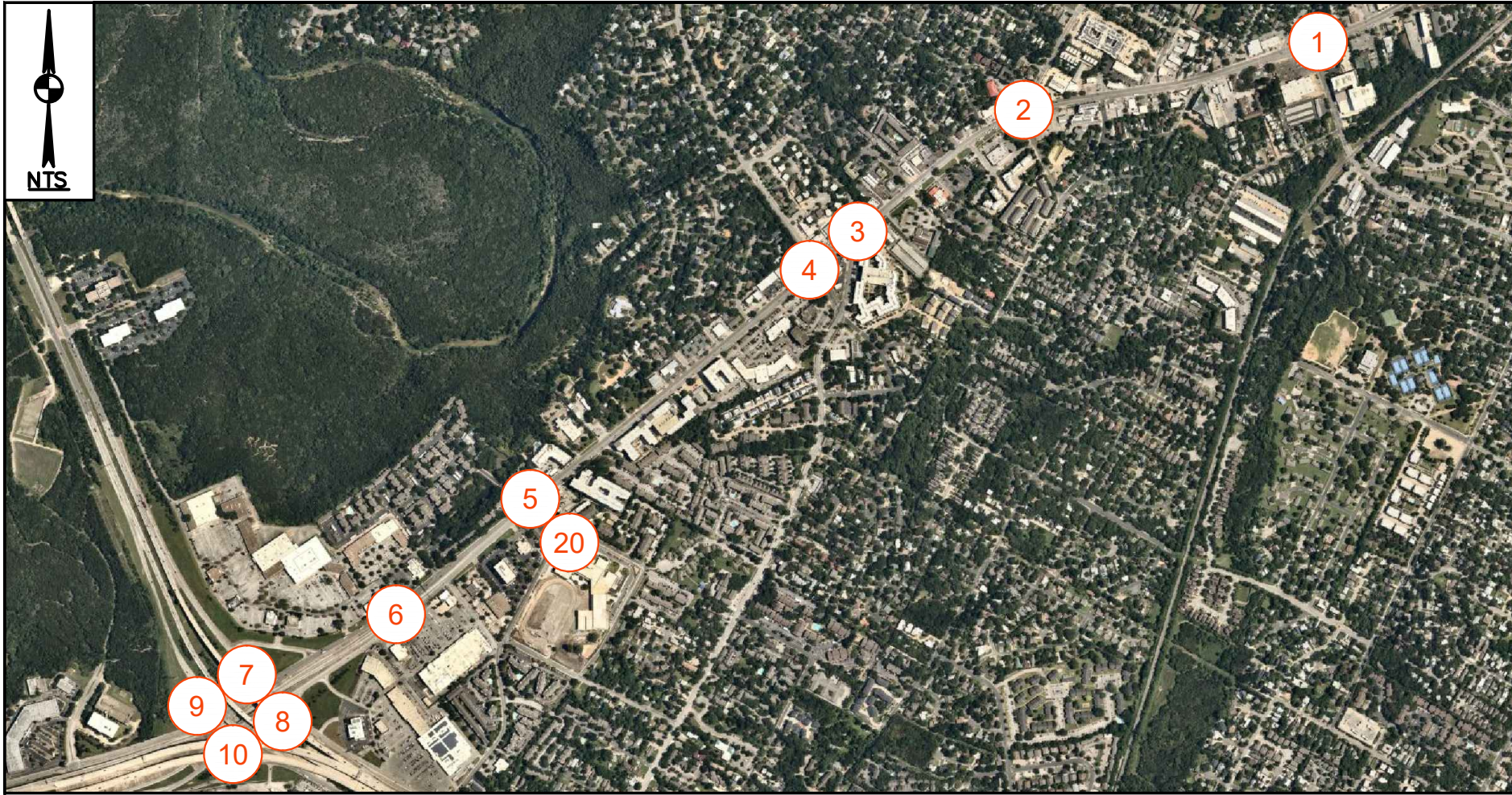

**LEGEND**  
 # STUDY INTERSECTION  
 ##(##) AM(PM) PEAK HOUR VOLUME

**FIGURE 1E**  
 2021 EXISTING (FINAL) - ADJUSTED AM & PM PEAK HOUR

**BOE Consulting Services, LLC**  
 9901 Brodie Lane 160-303  
 Austin, Texas 78748  
 Tel. (512) 632-7509  
 TBPE Registration Number F-19220



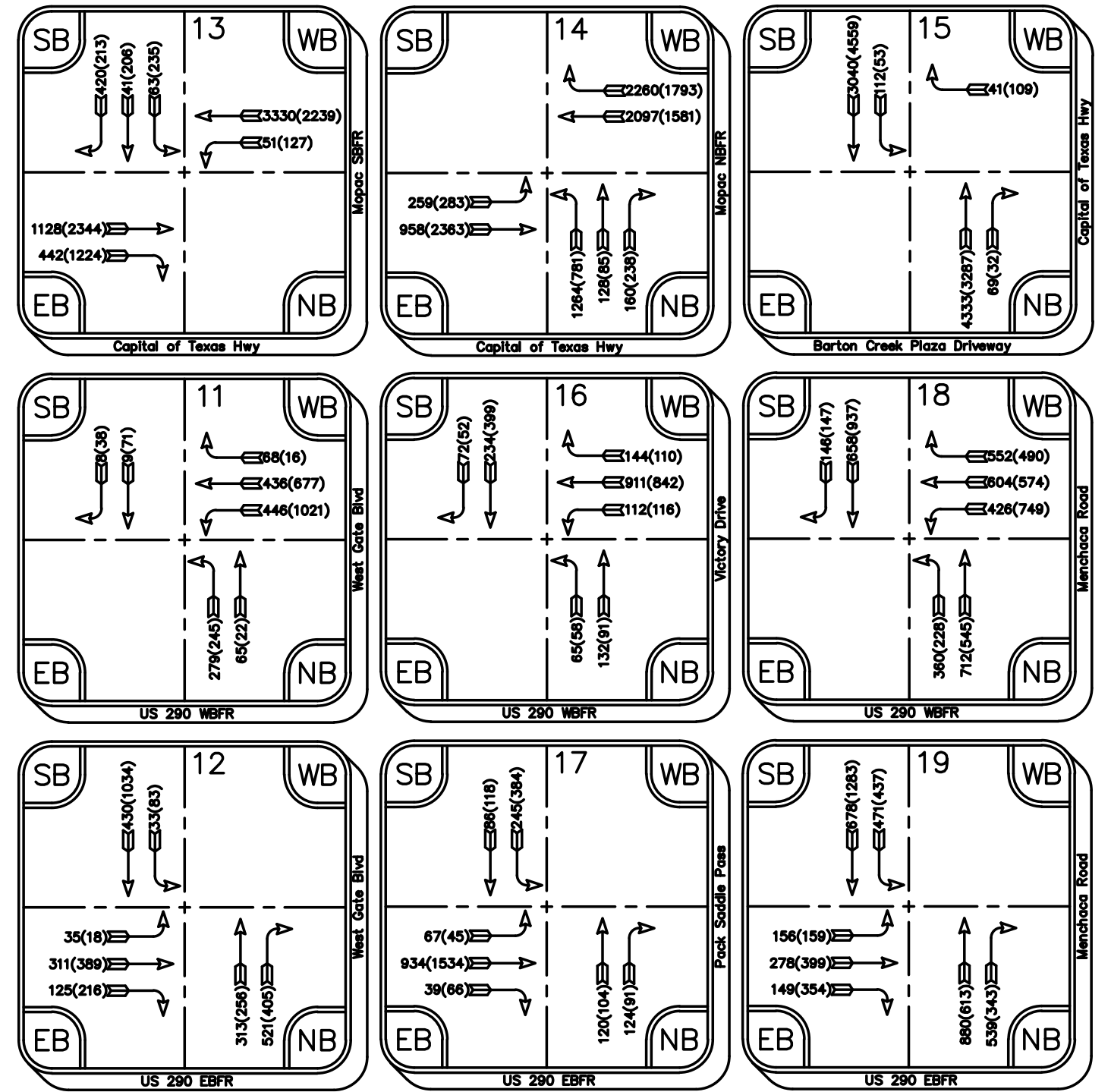
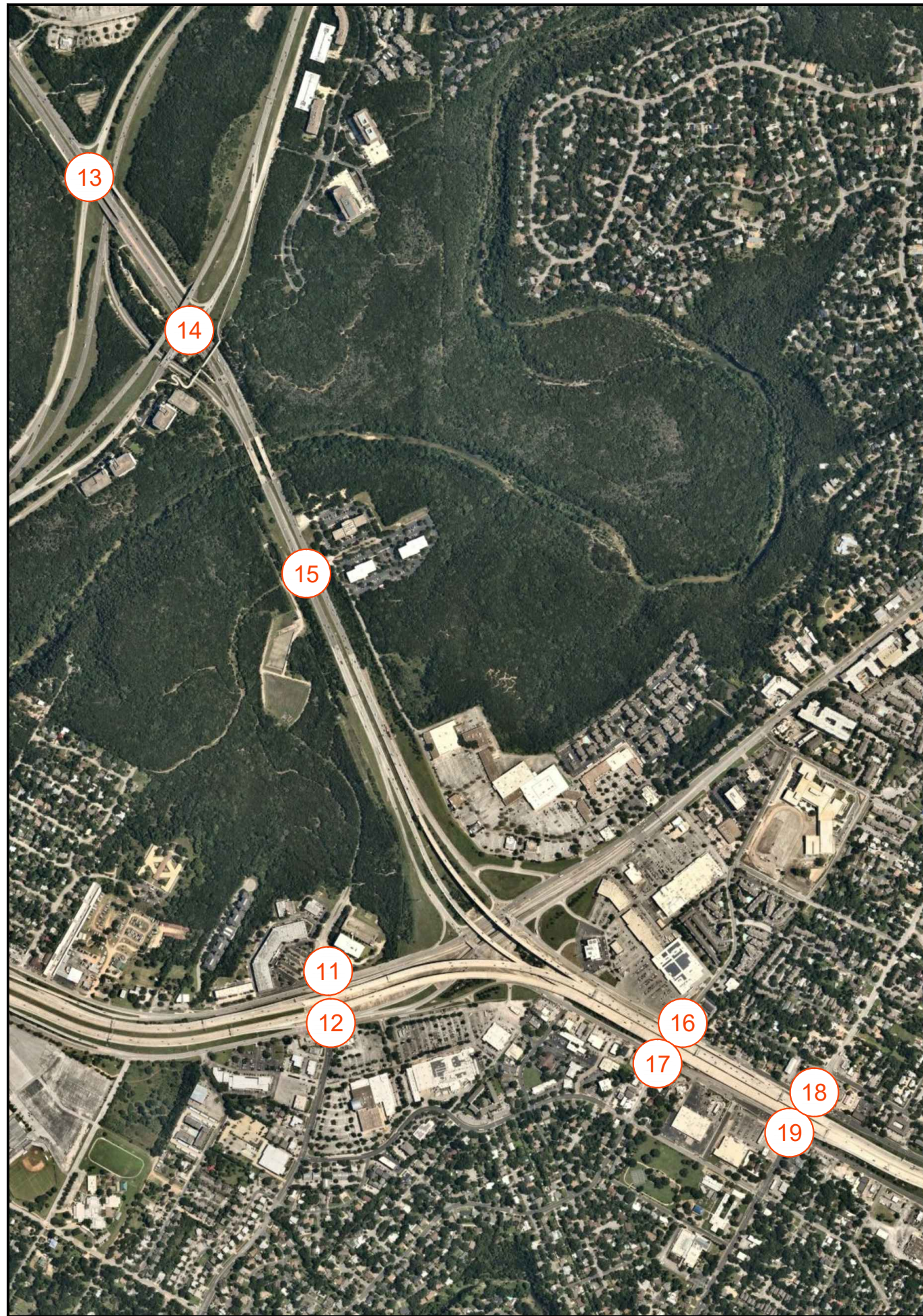

**LEGEND**  
 # STUDY INTERSECTION  
 ##(##) AM(PM) PEAK HOUR VOLUME

FIGURE 1E  
 2021 EXISTING  
 (FINAL) - ADJUSTED  
 AM & PM PEAK HOUR

**BOE** Consulting Services, LLC  
 9901 Brodie Lane 160-303  
 Austin, Texas 78748  
 Tel. (512) 632-7509  
 TBPE Registration Number F-19220



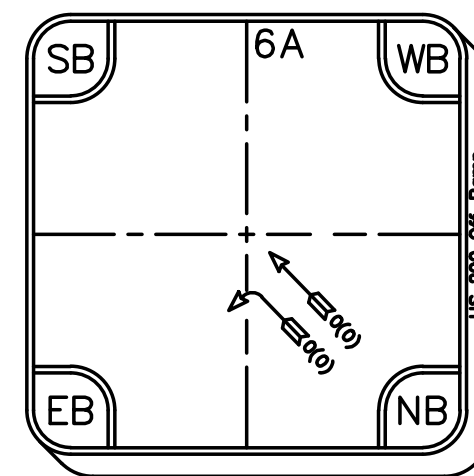
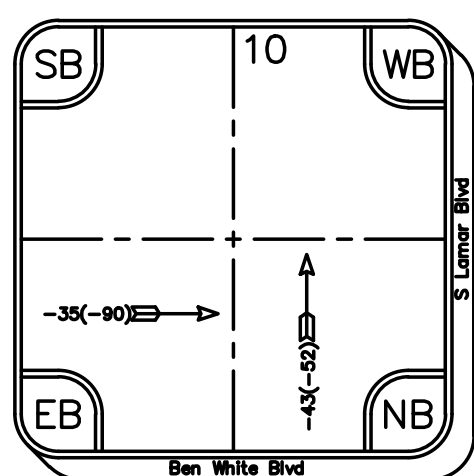
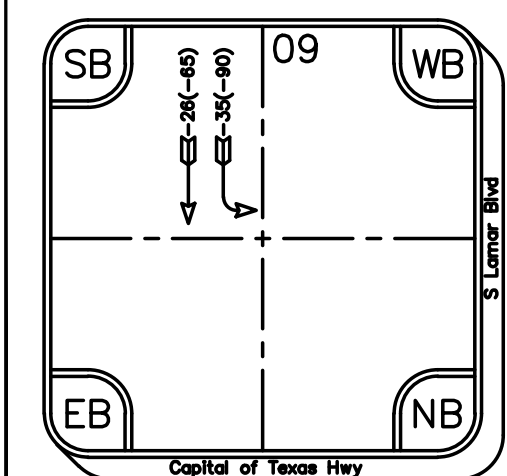
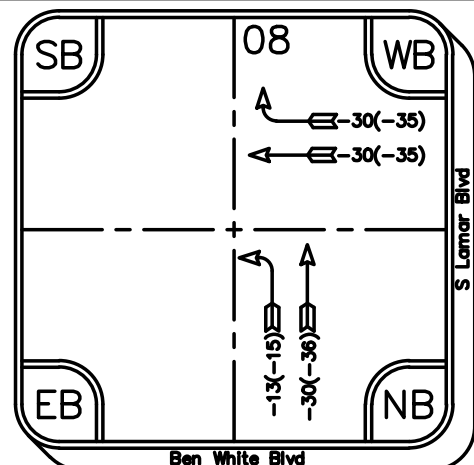
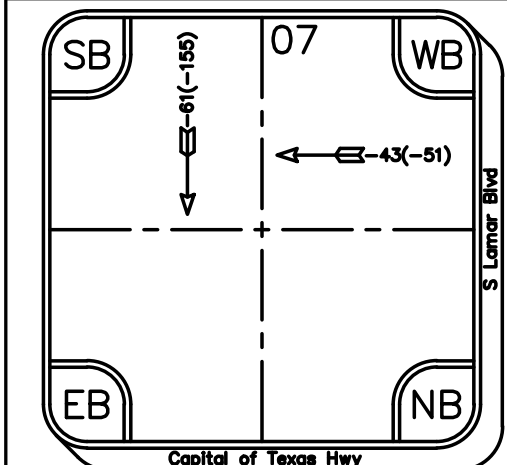
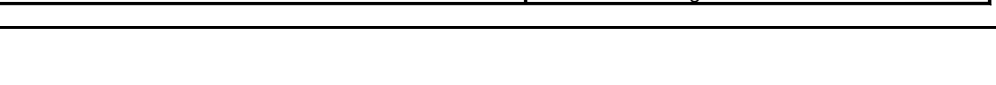
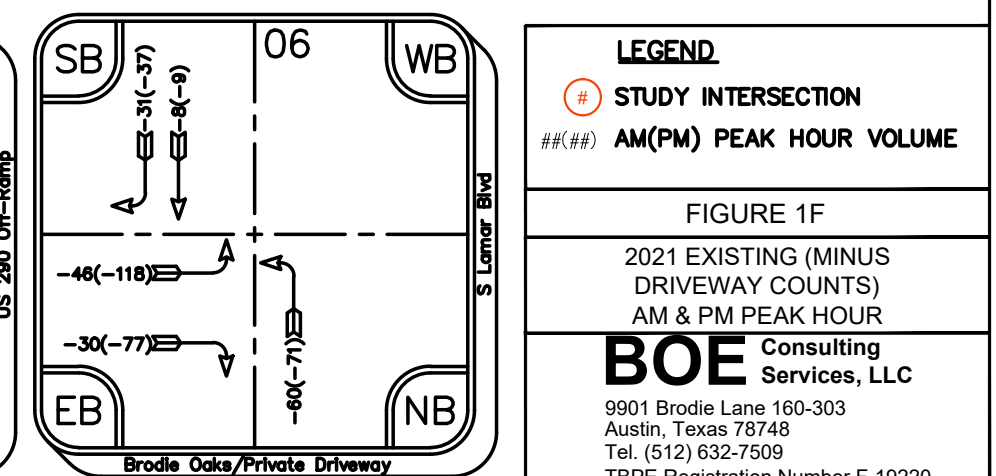
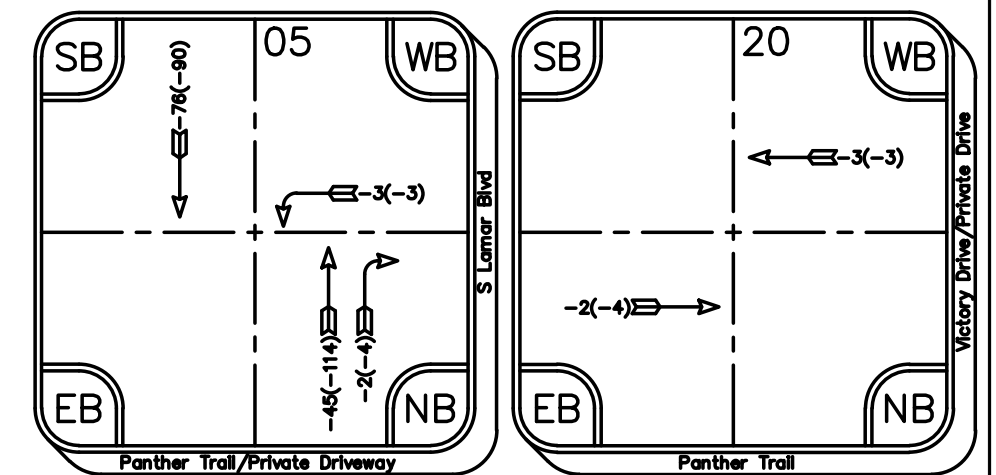
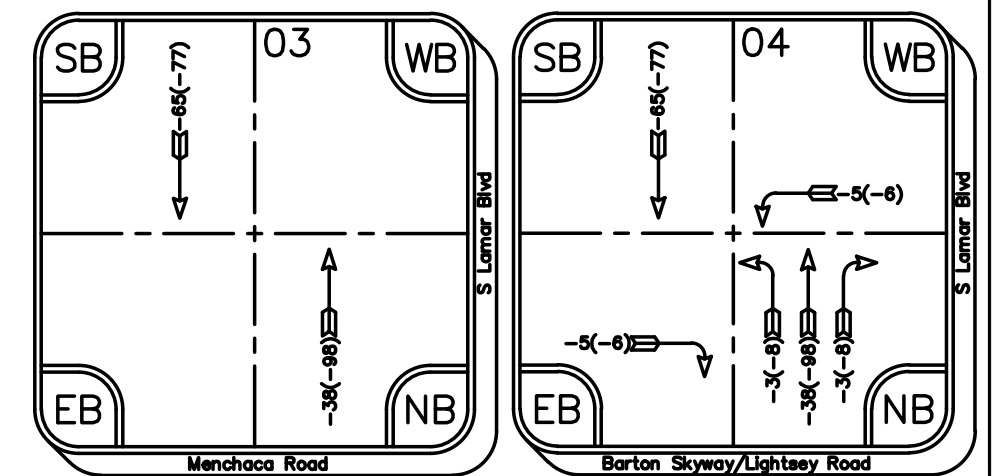
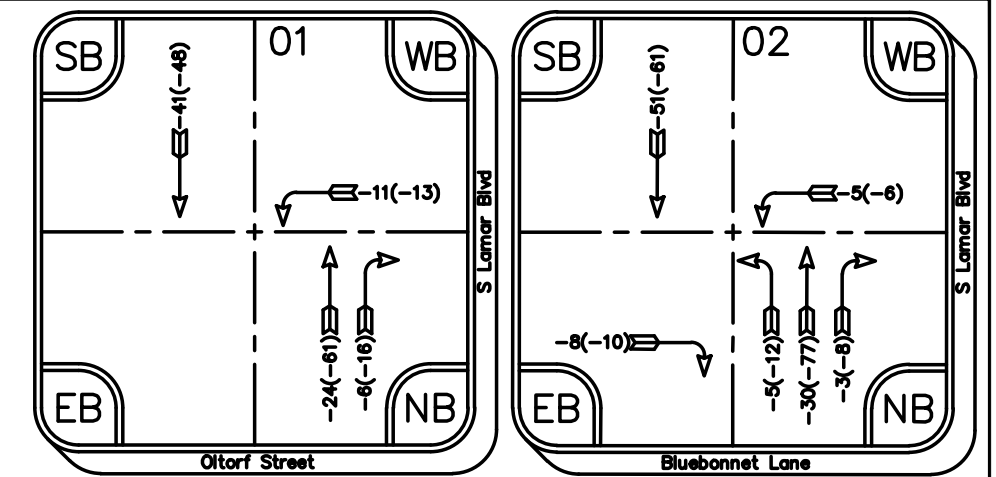
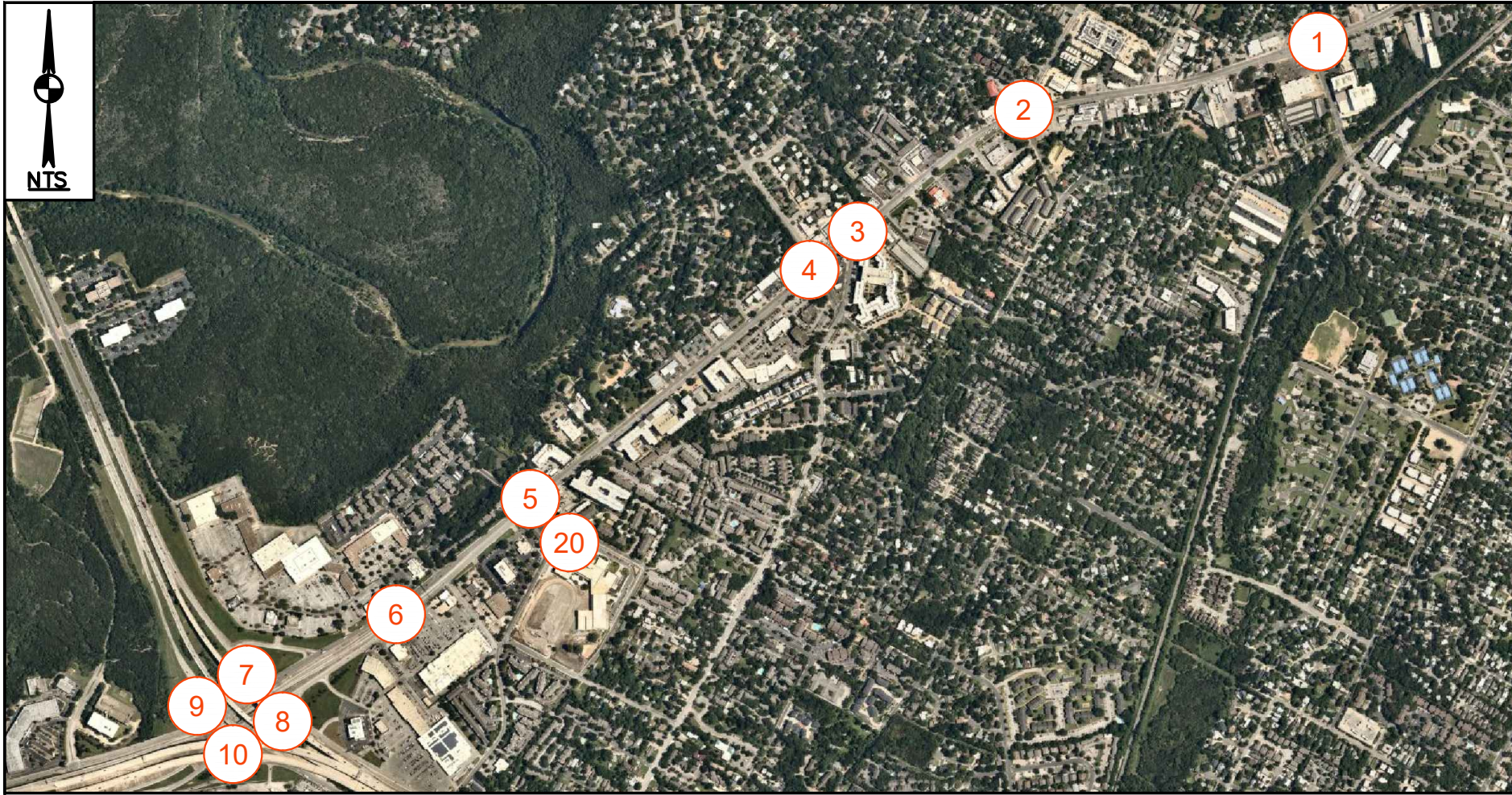

**LEGEND**  
 # STUDY INTERSECTION  
 ##(##) AM(PM) PEAK HOUR VOLUME

FIGURE 1F  
 2021 EXISTING (MINUS DRIVEWAY COUNTS)  
 AM & PM PEAK HOUR

**BOE** Consulting Services, LLC  
 9901 Brodie Lane 160-303  
 Austin, Texas 78748  
 Tel. (512) 632-7509  
 TBPE Registration Number F-19220



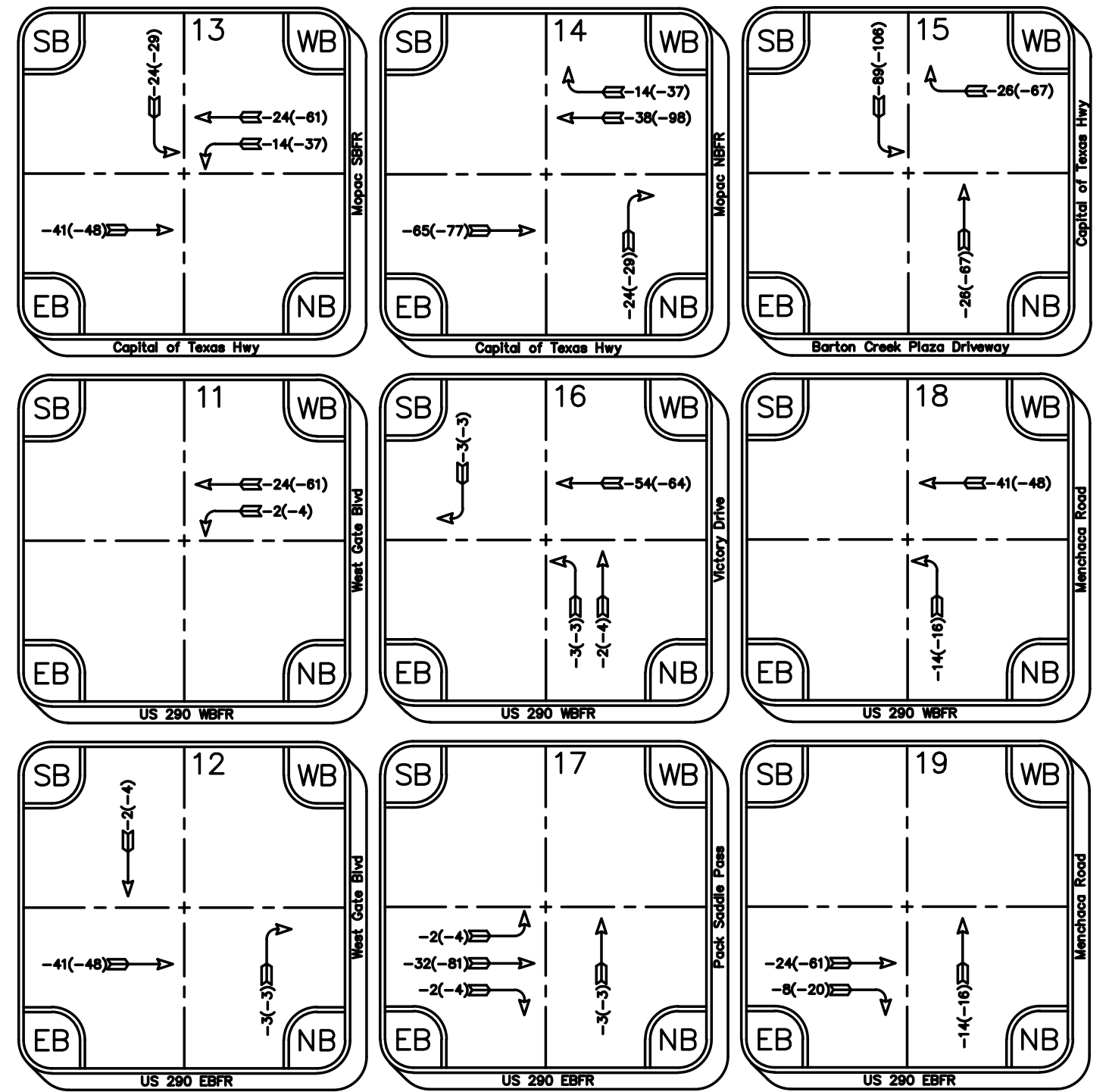
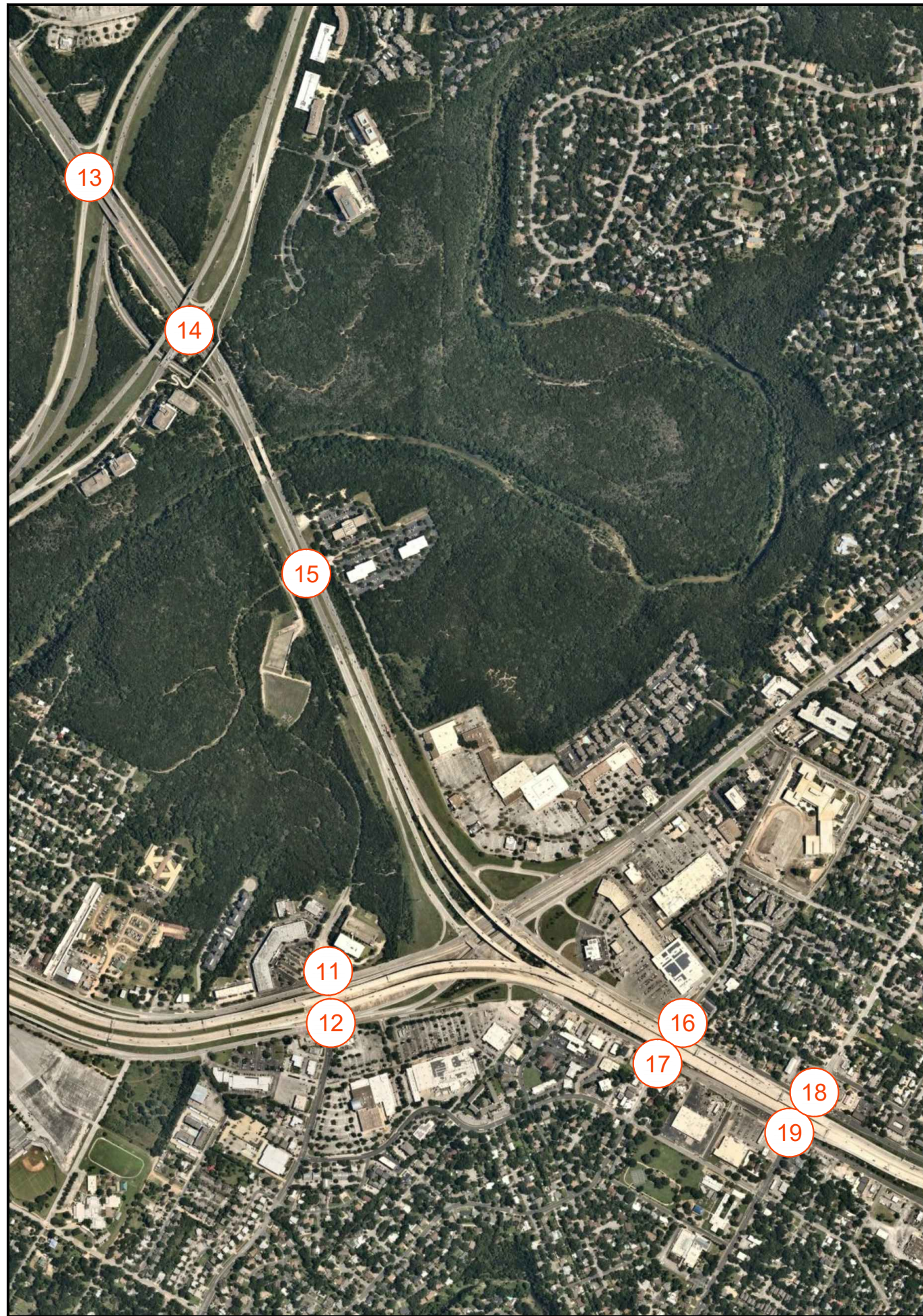

**LEGEND**  
 # STUDY INTERSECTION  
 ##(##) AM(PM) PEAK HOUR VOLUME

FIGURE 1F  
 2021 EXISTING (MINUS  
 DRIVEWAY COUNTS)  
 AM & PM PEAK HOUR

**BOE** Consulting Services, LLC  
 9901 Brodie Lane 160-303  
 Austin, Texas 78748  
 Tel. (512) 632-7509  
 TBPE Registration Number F-19220



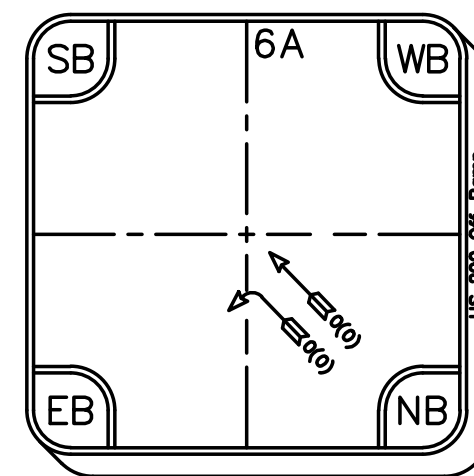
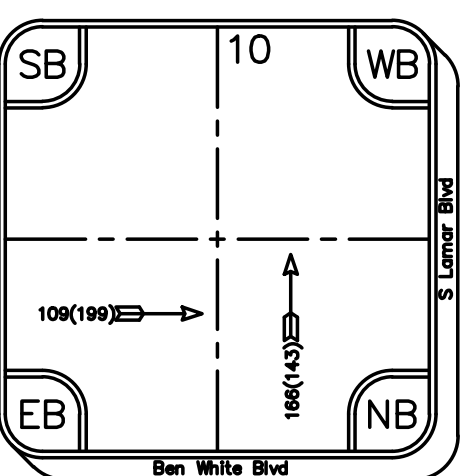
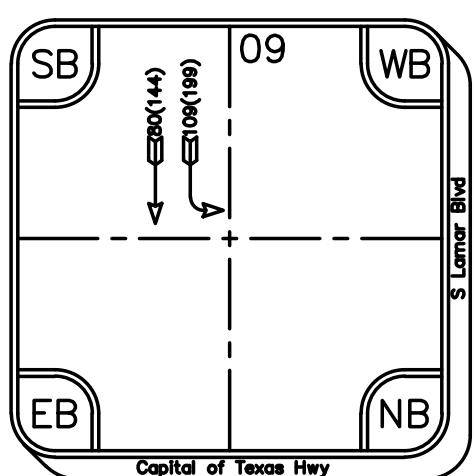
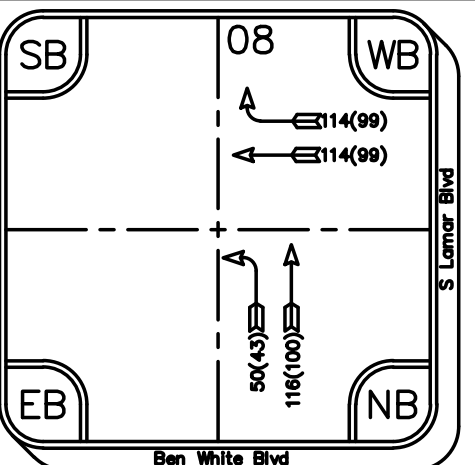
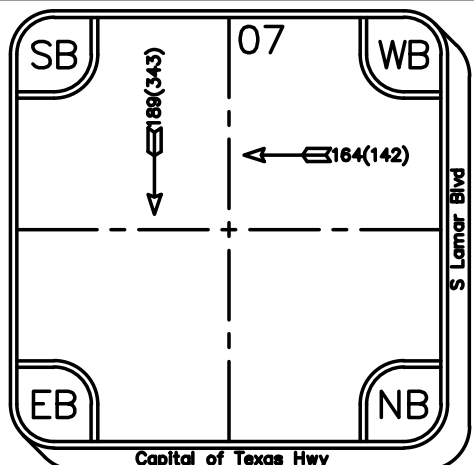
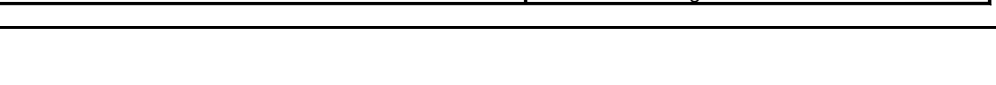
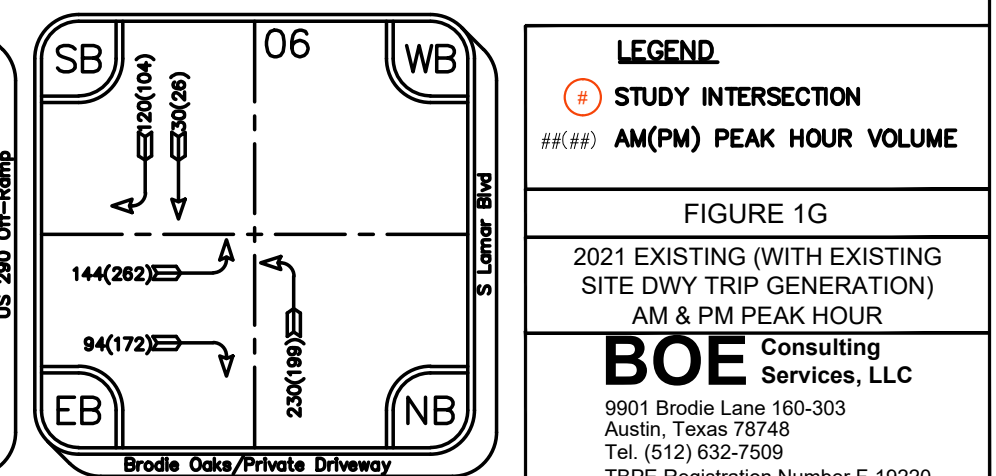
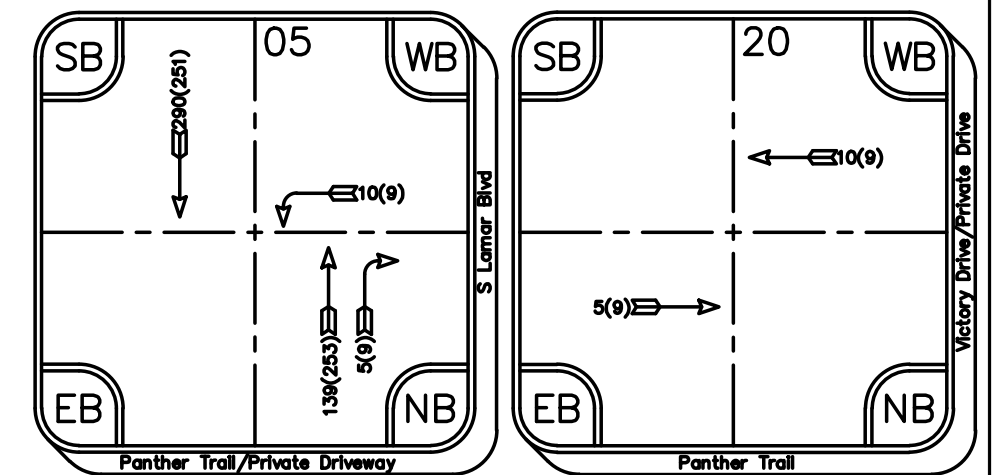
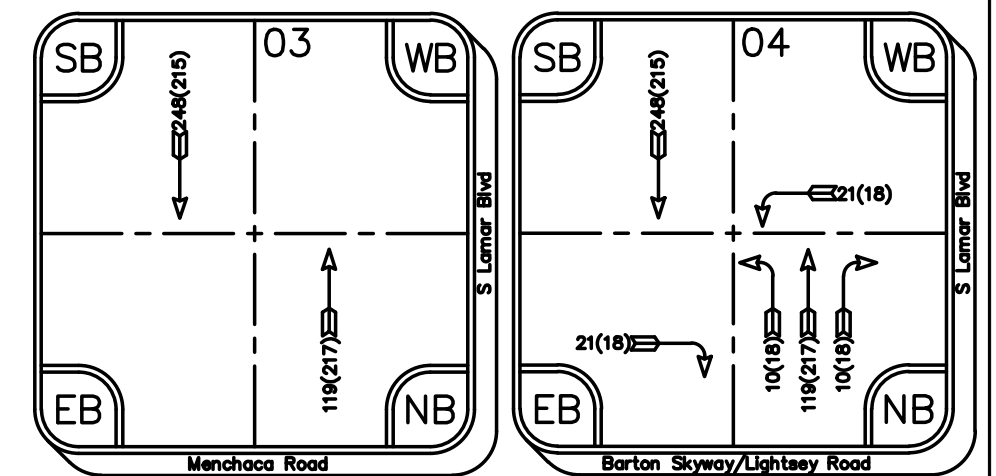
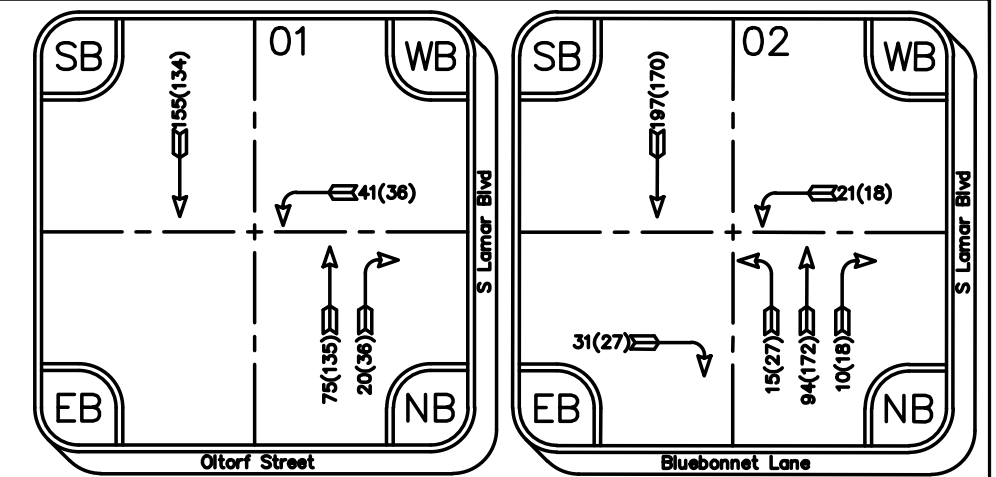
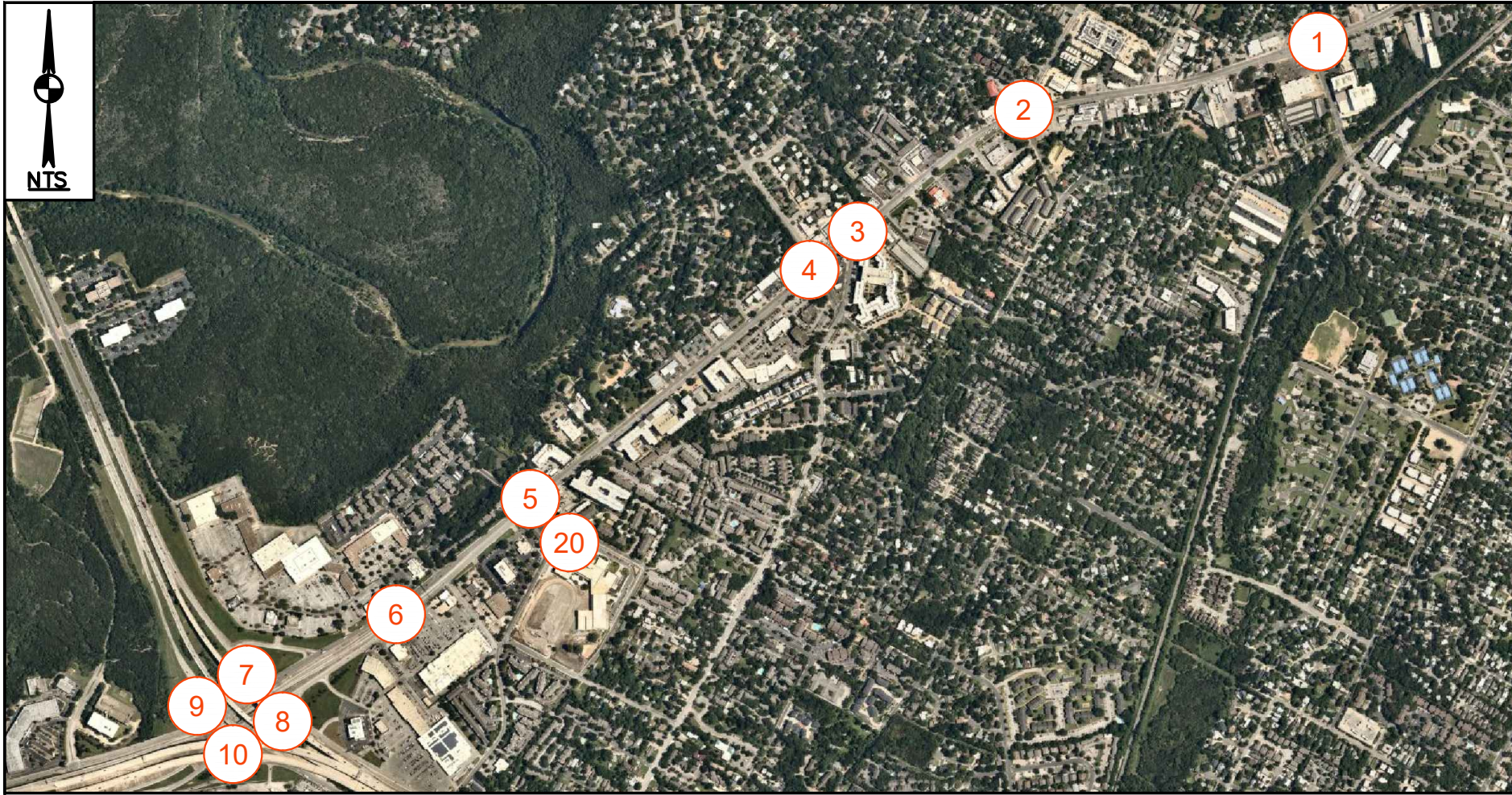

**LEGEND**

- ⊙ STUDY INTERSECTION
- ##(##) AM(PM) PEAK HOUR VOLUME

**FIGURE 1G**

2021 EXISTING (WITH EXISTING SITE DWY TRIP GENERATION)  
AM & PM PEAK HOUR

**BOE** Consulting Services, LLC  
9901 Brodie Lane 160-303  
Austin, Texas 78748  
Tel. (512) 632-7509  
TBPE Registration Number F-19220



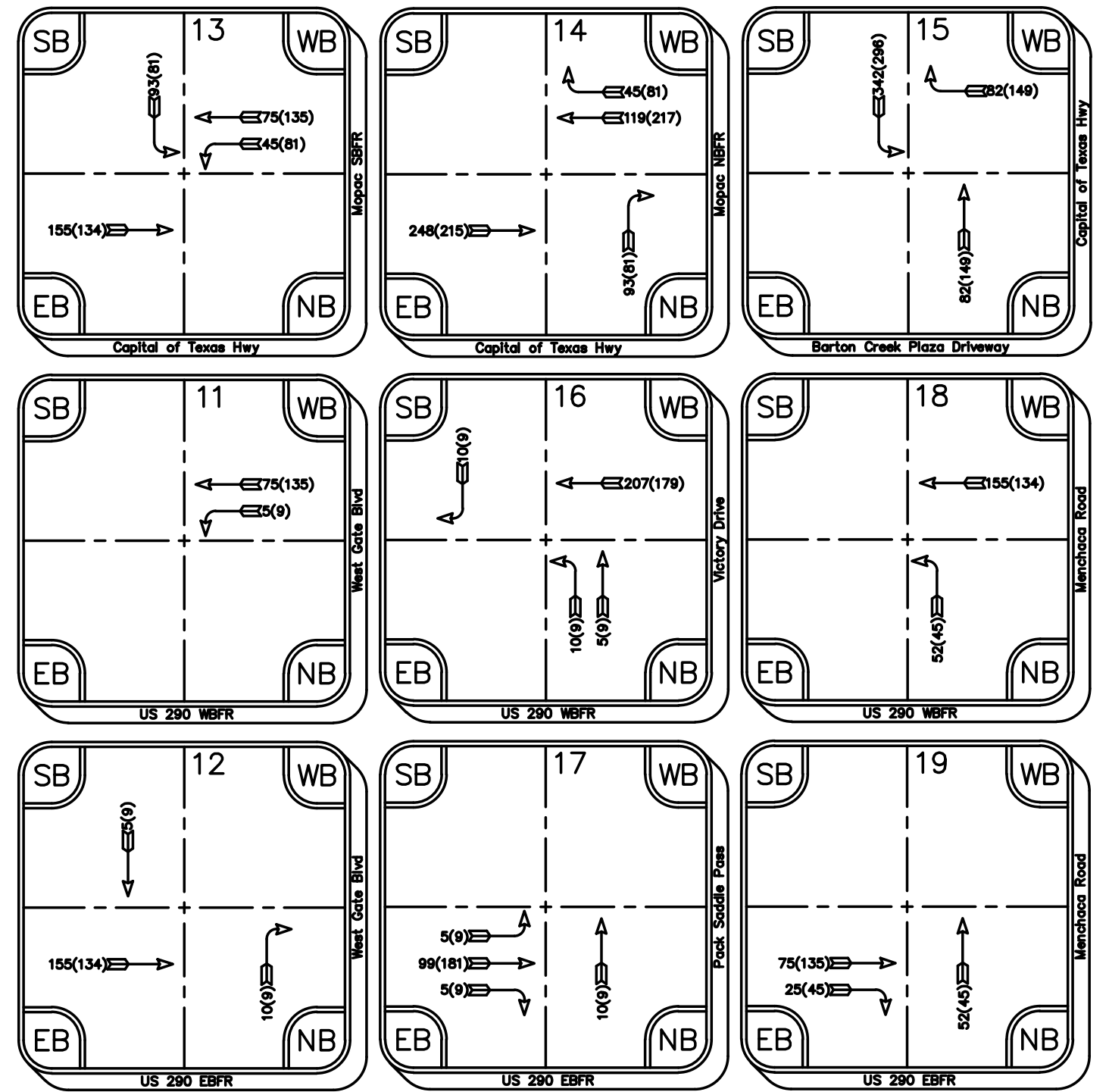
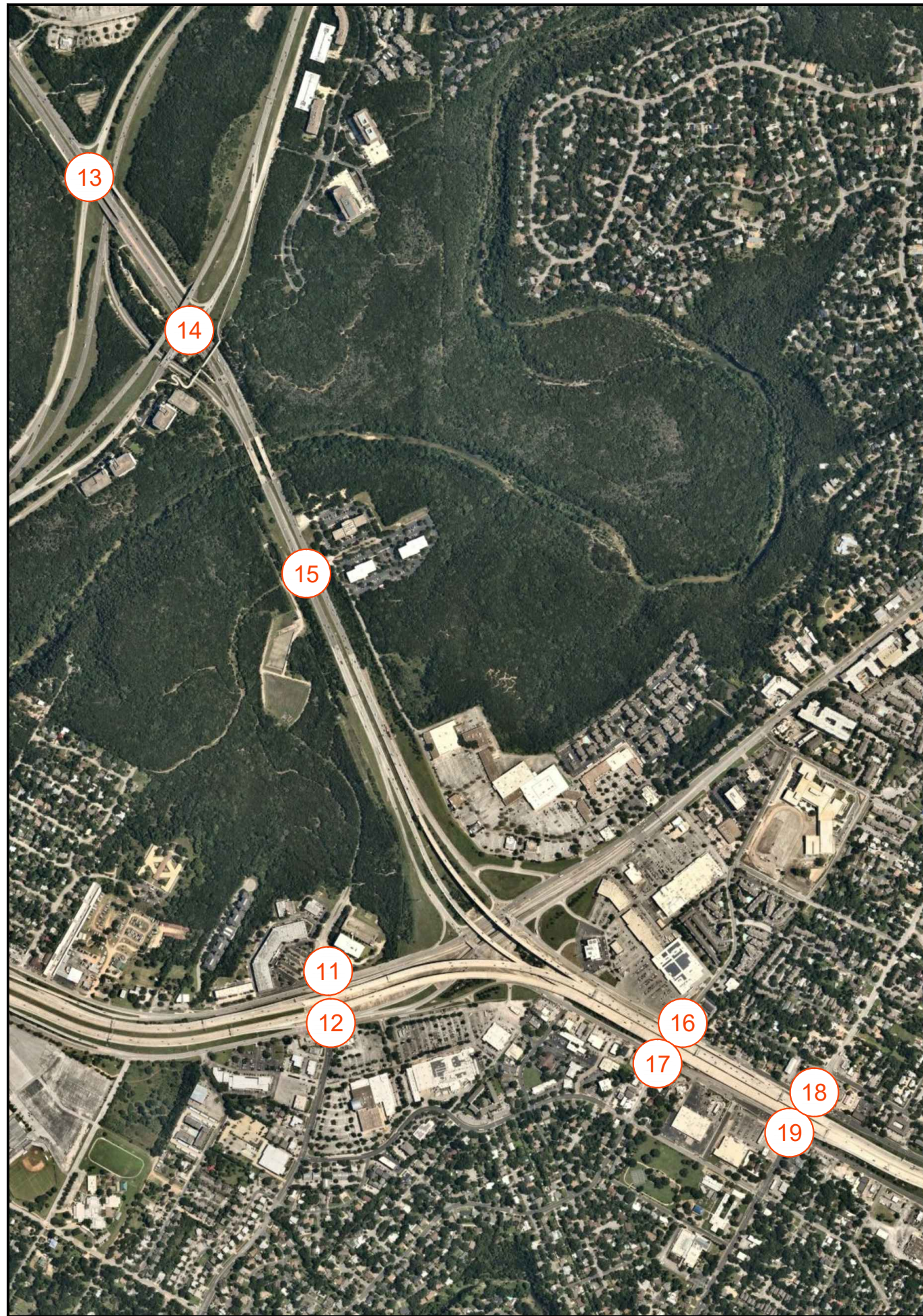

**LEGEND**  
 # STUDY INTERSECTION  
 ##(##) AM(PM) PEAK HOUR VOLUME

FIGURE 1G  
 2021 EXISTING (WITH EXISTING SITE DWY TRIP GENERATION)  
 AM & PM PEAK HOUR

**BOE** Consulting Services, LLC  
 9901 Brodie Lane 160-303  
 Austin, Texas 78748  
 Tel. (512) 632-7509  
 TBPE Registration Number F-19220



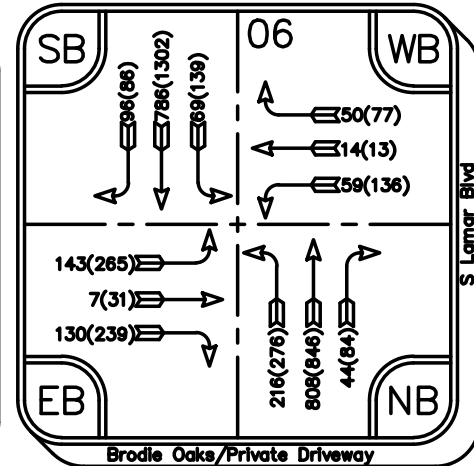
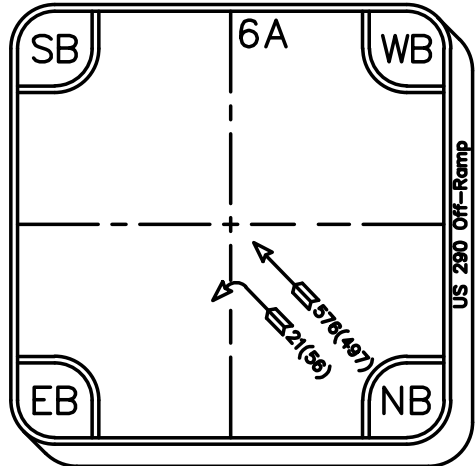
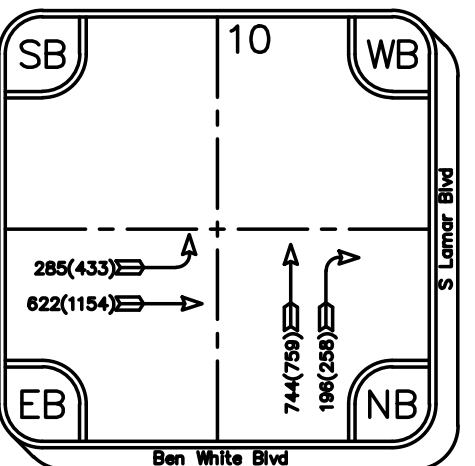
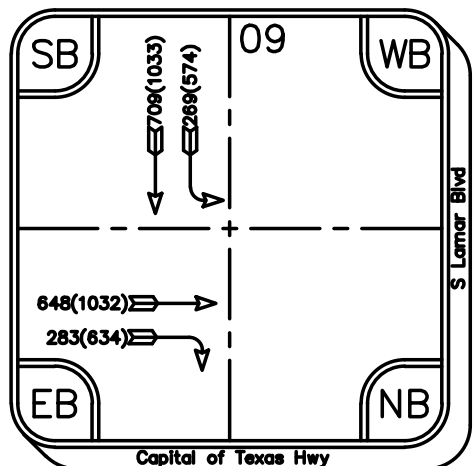
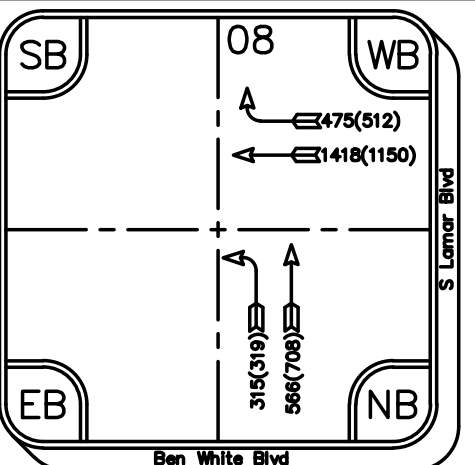
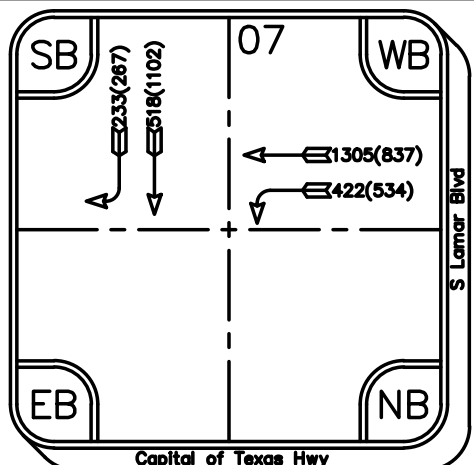
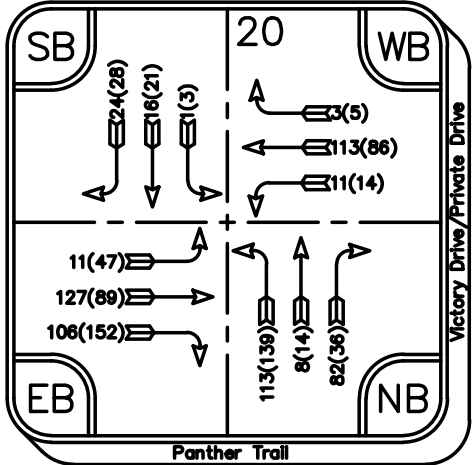
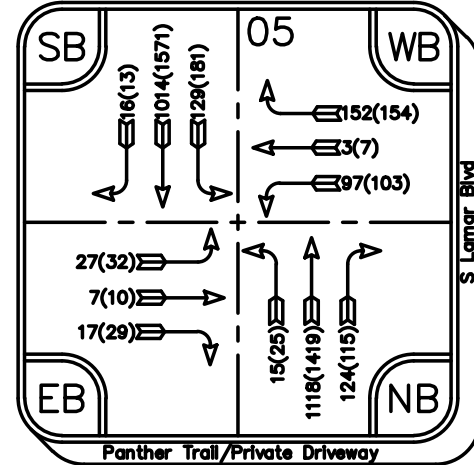
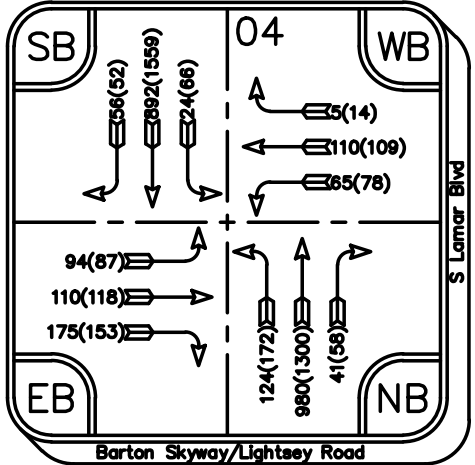
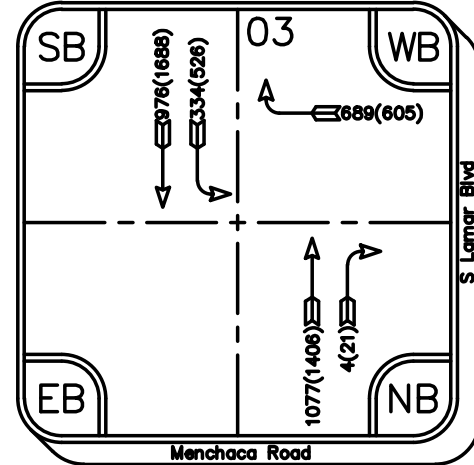
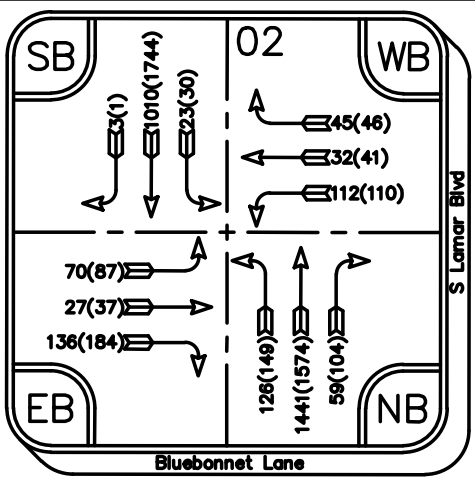
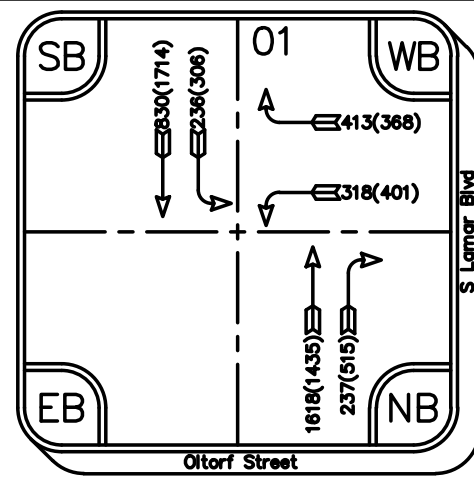
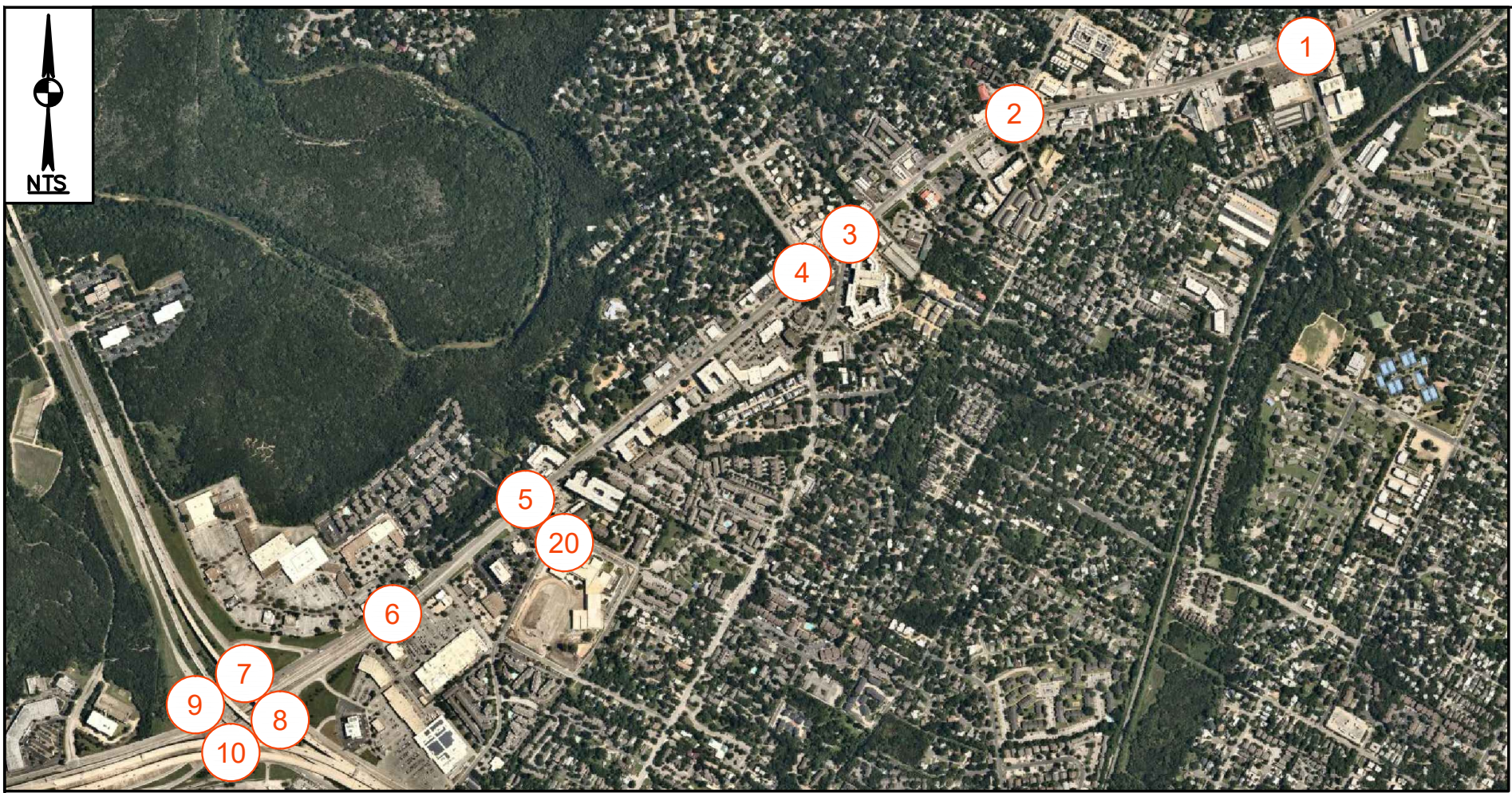

**LEGEND**  
 # STUDY INTERSECTION  
 ##(##) AM(PM) PEAK HOUR VOLUME

FIGURE 1H  
 2021 EXISTING FINAL  
 AM & PM PEAK HOUR  
**BOE** Consulting Services, LLC  
 9901 Brodie Lane 160-303  
 Austin, Texas 78748  
 Tel. (512) 632-7509  
 TBPE Registration Number F-19220



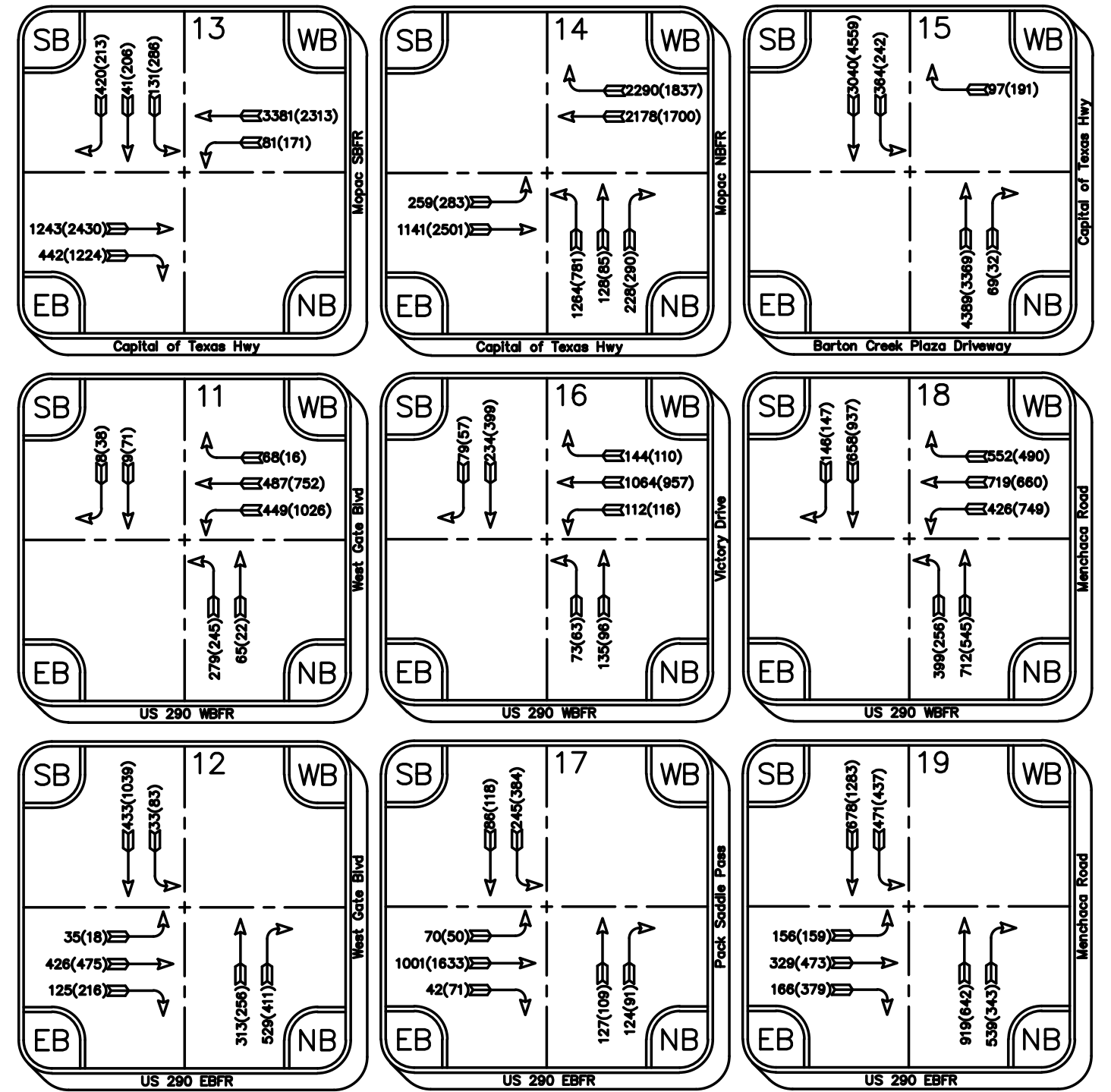
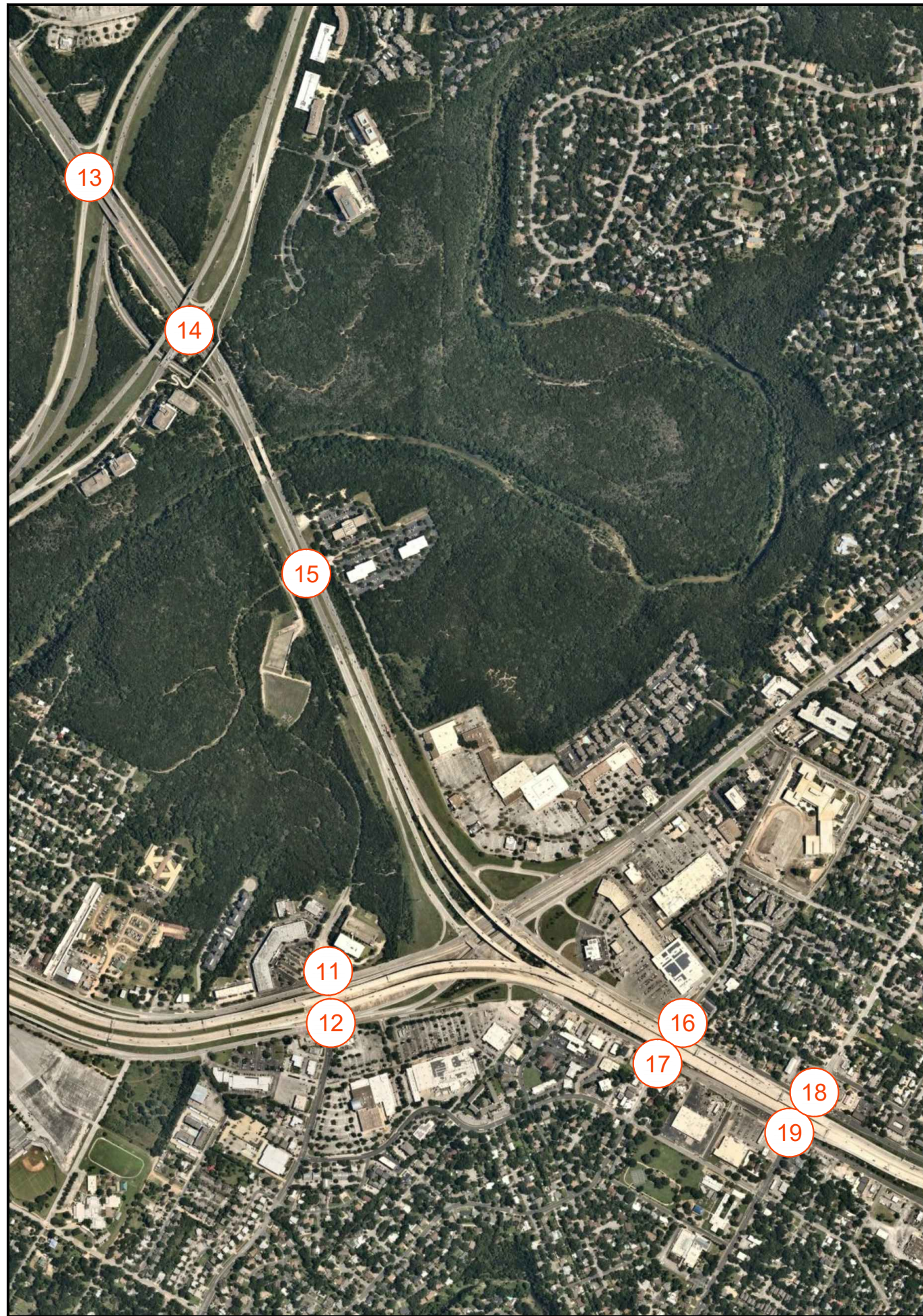

**LEGEND**  
 # STUDY INTERSECTION  
 ##(##) AM(PM) PEAK HOUR VOLUME

FIGURE 1H  
 2021 EXISTING FINAL  
 AM & PM PEAK HOUR

**BOE** Consulting Services, LLC  
 9901 Brodie Lane 160-303  
 Austin, Texas 78748  
 Tel. (512) 632-7509  
 TBPE Registration Number F-19220



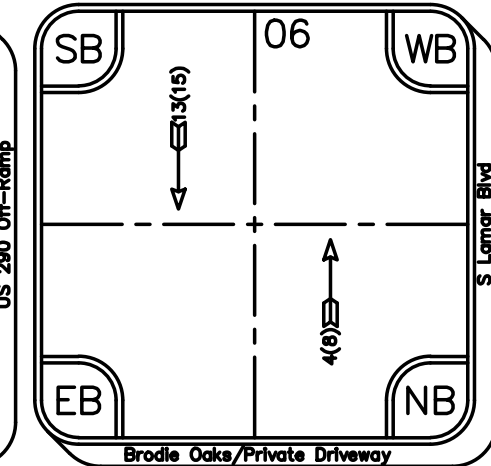
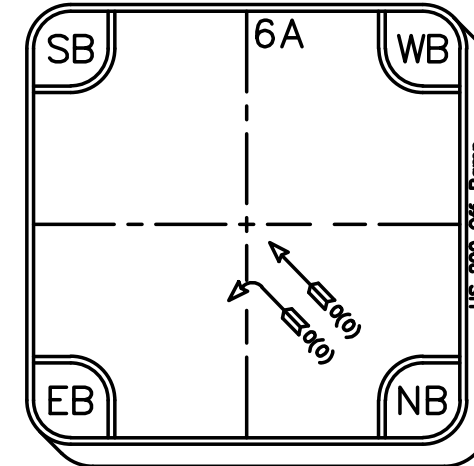
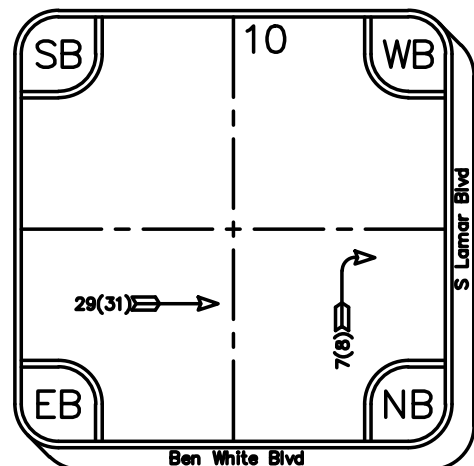
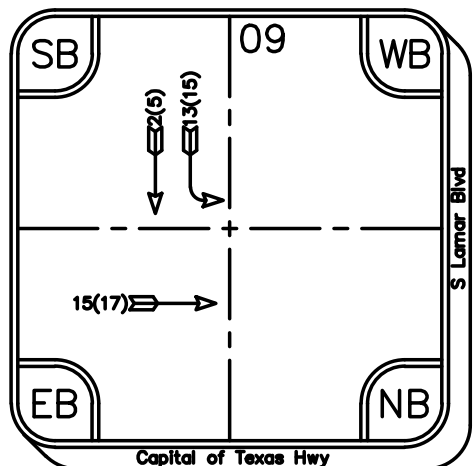
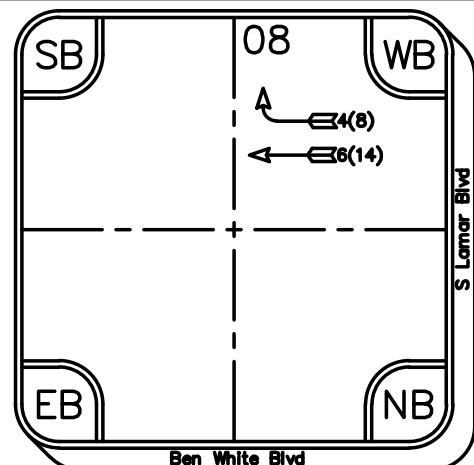
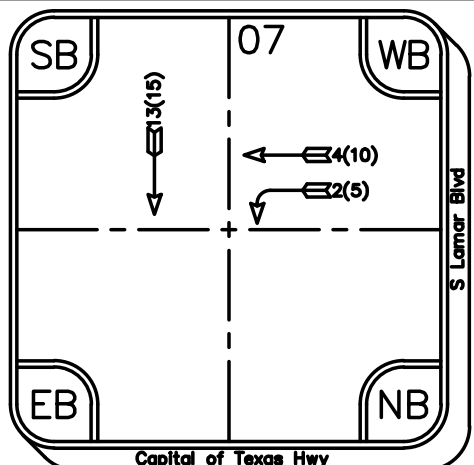
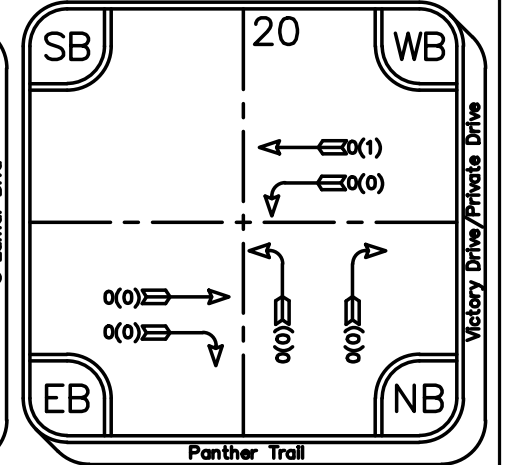
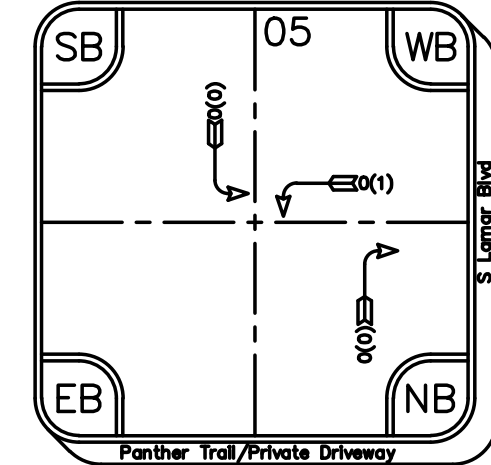
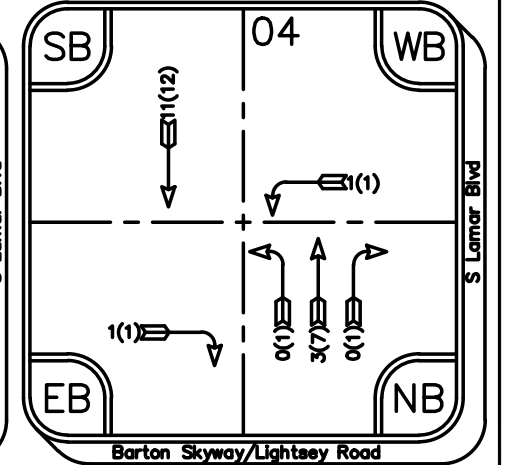
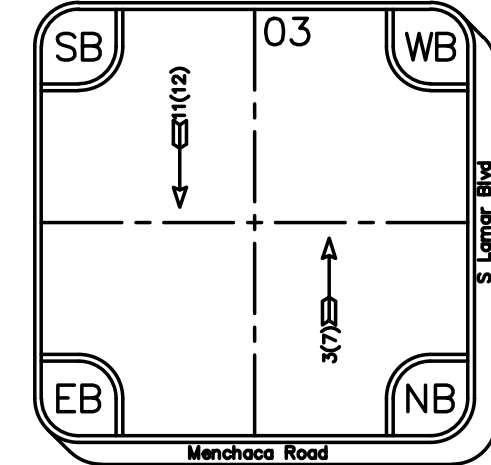
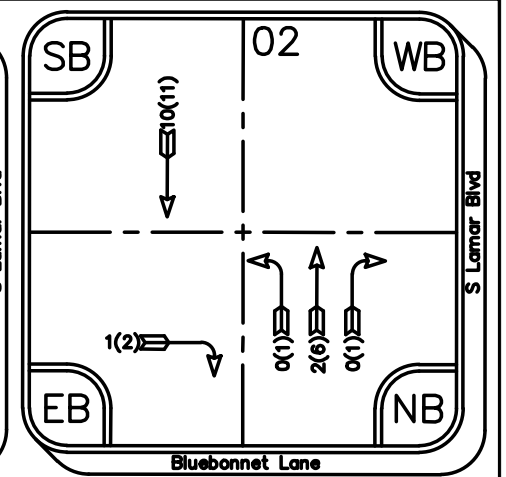
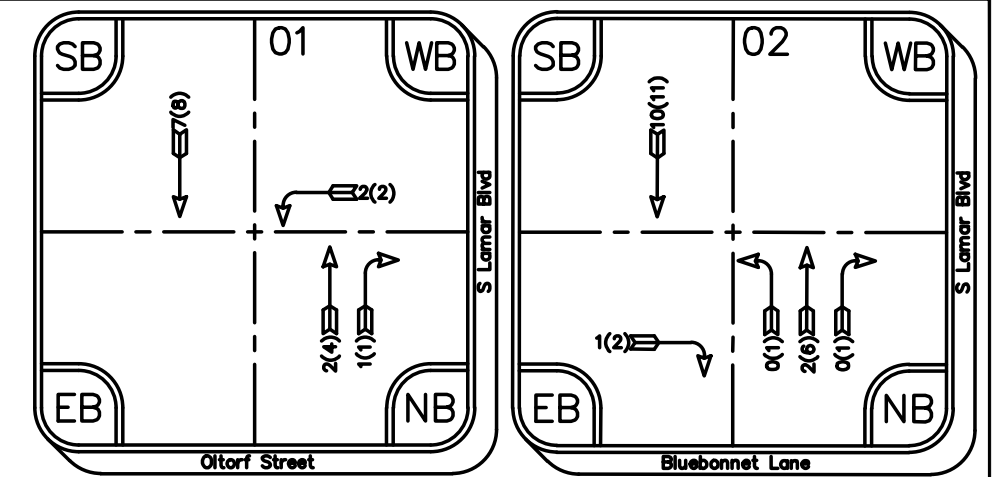
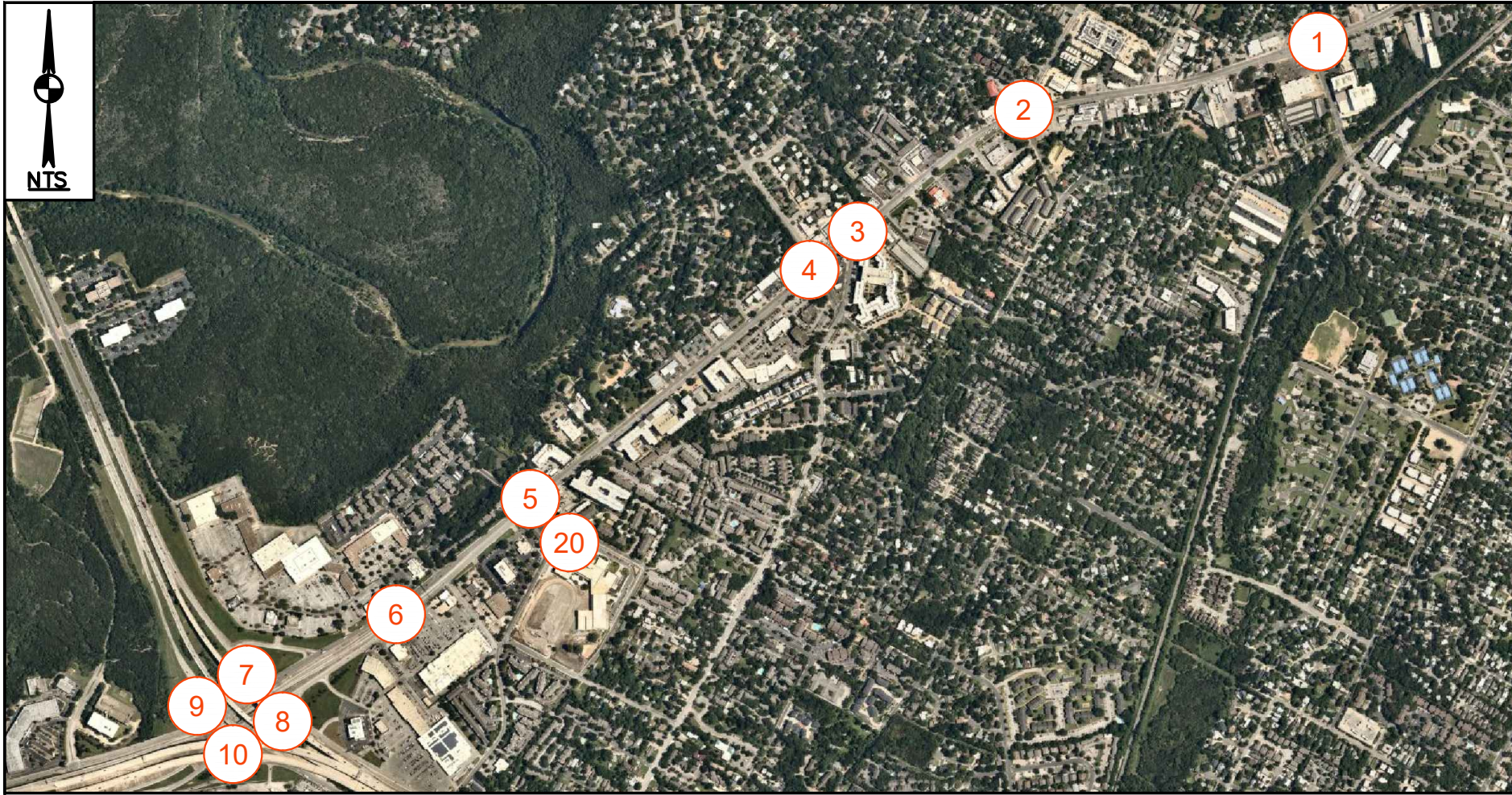

**LEGEND**  
 # STUDY INTERSECTION  
 ##(##) AM(PM) PEAK HOUR VOLUME

FIGURE 2A  
 BACKGROUND VOLUME  
 (VICTORY MEDICAL)  
 AM & PM PEAK HOUR

**BOE** Consulting Services, LLC  
 9901 Brodie Lane 160-303  
 Austin, Texas 78748  
 Tel. (512) 632-7509  
 TBPE Registration Number F-19220



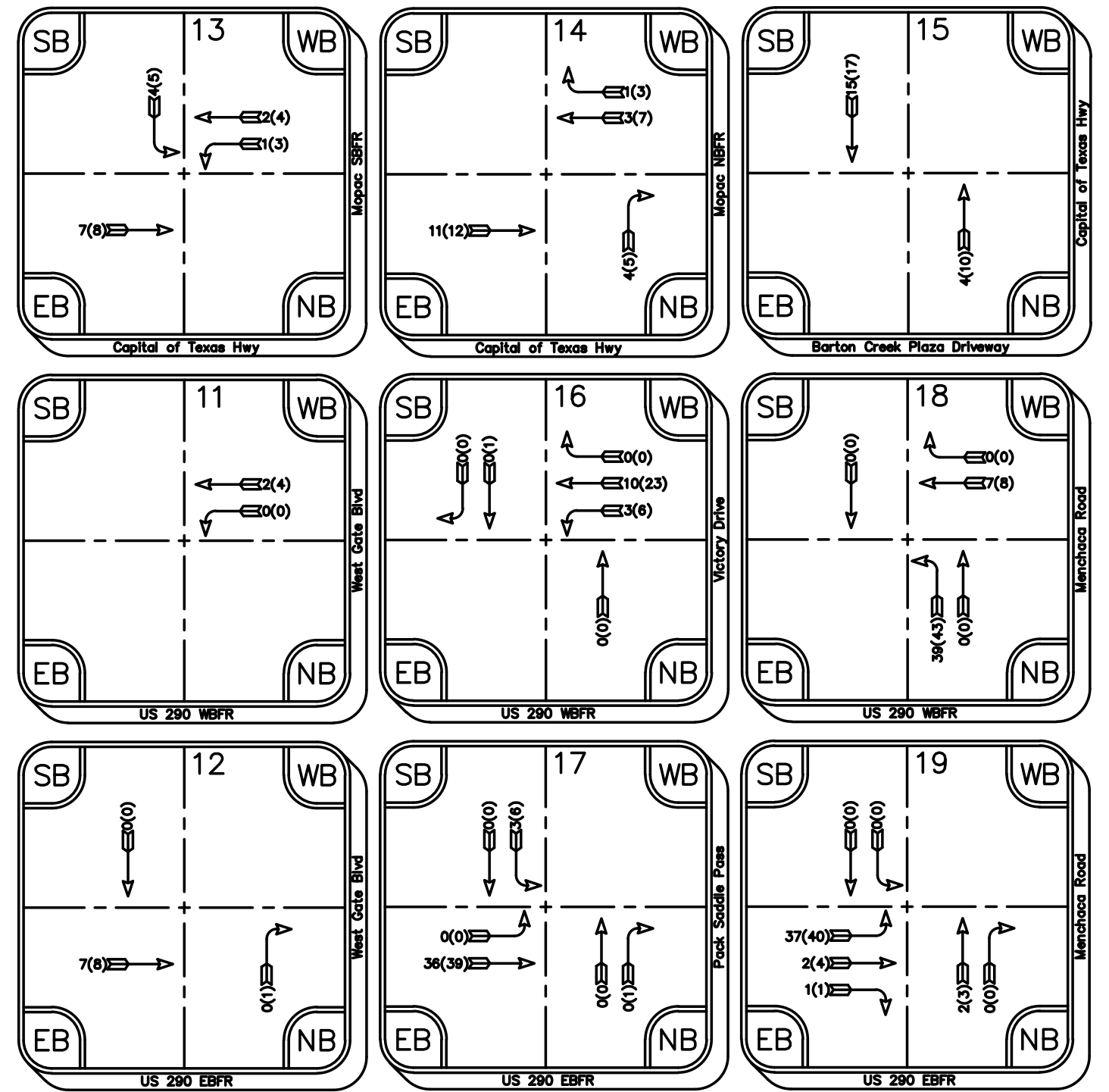
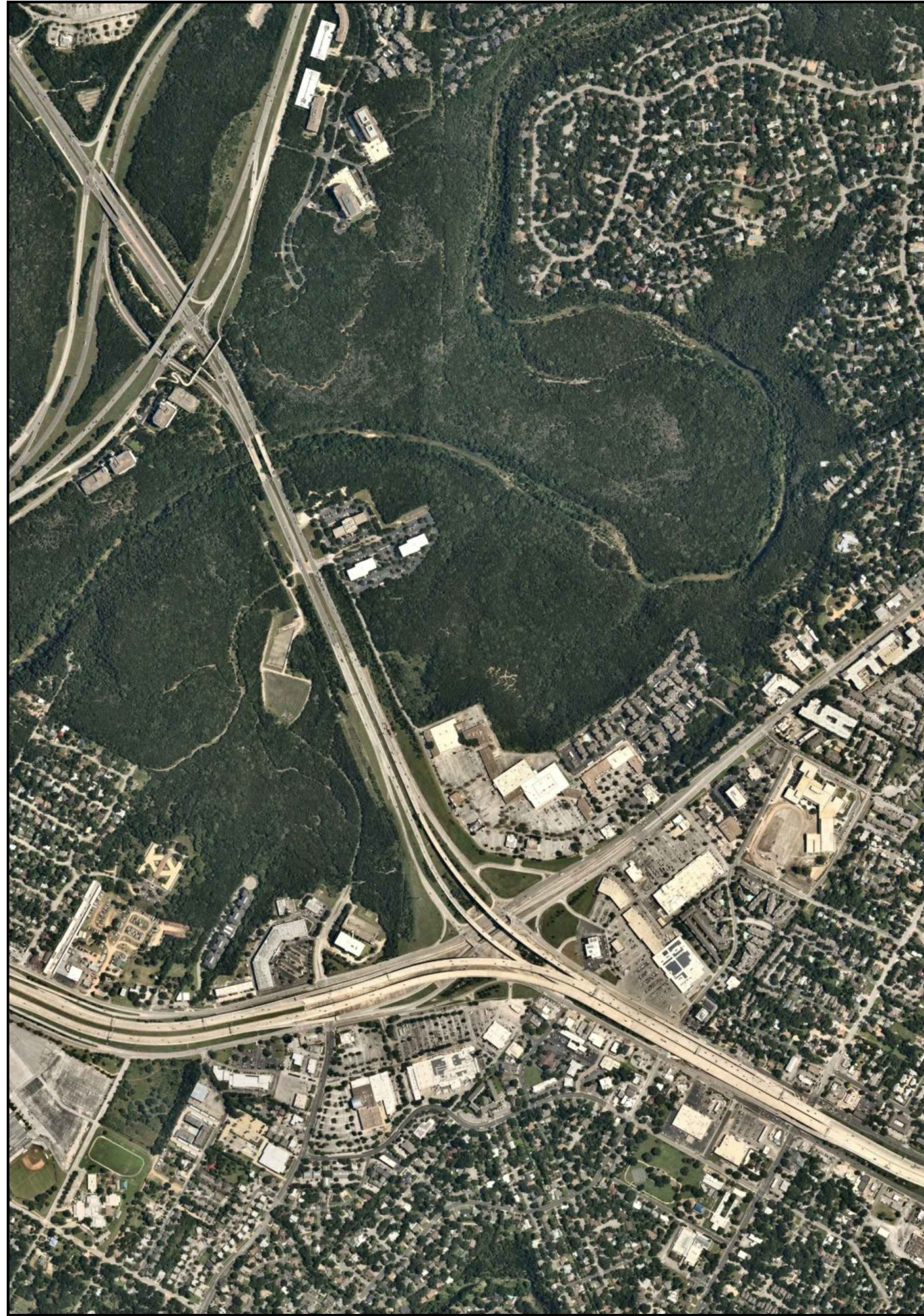

**LEGEND**  
 # STUDY INTERSECTION  
 ##(##) AM(PM) PEAK HOUR VOLUME

FIGURE 2A  
 BACKGROUND VOLUME  
 (VICTORY MEDICAL)  
 AM & PM PEAK HOUR

**BOE** Consulting Services, LLC  
 9901 Brodie Lane 160-303  
 Austin, Texas 78748  
 Tel. (512) 632-7509  
 TBPE Registration Number F-19220



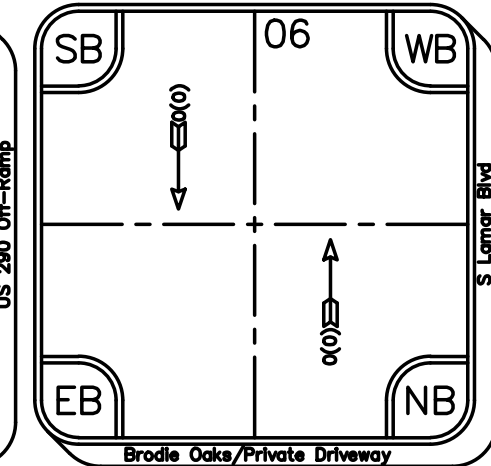
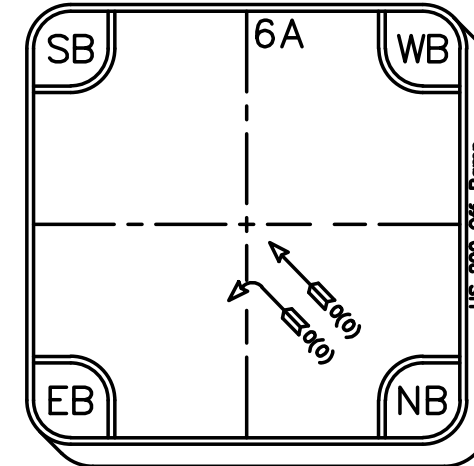
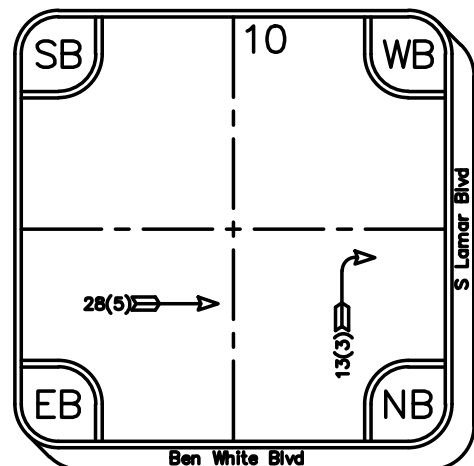
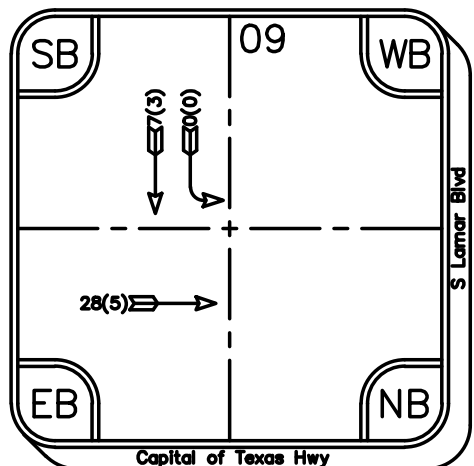
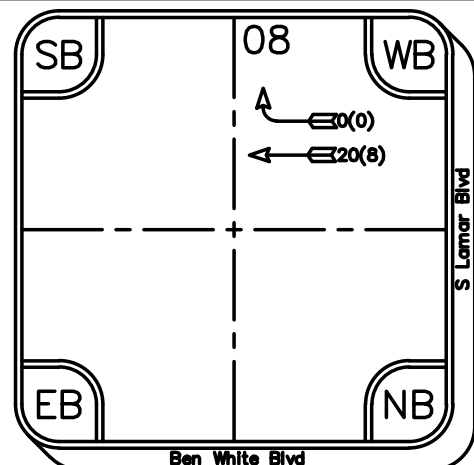
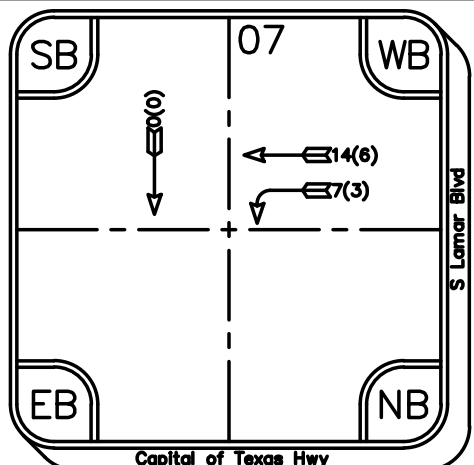
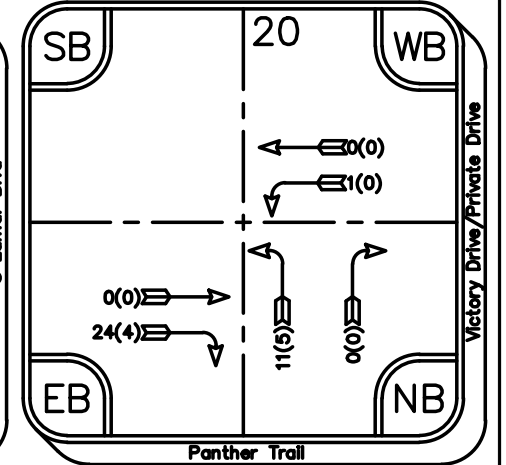
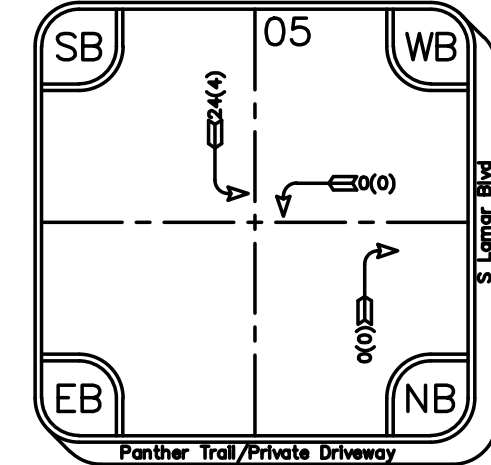
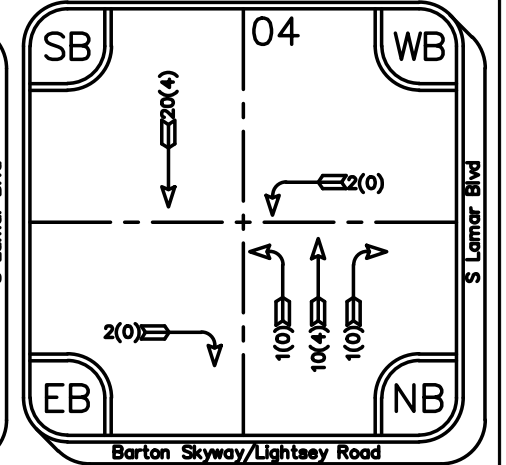
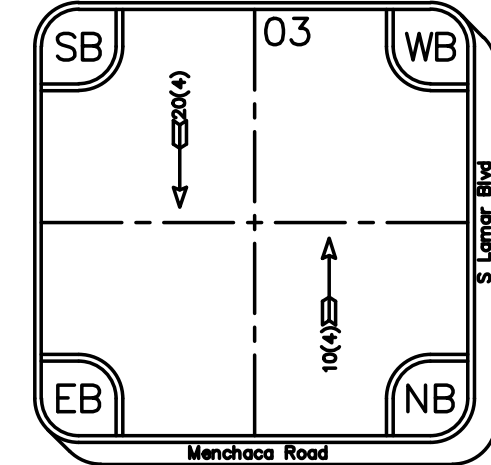
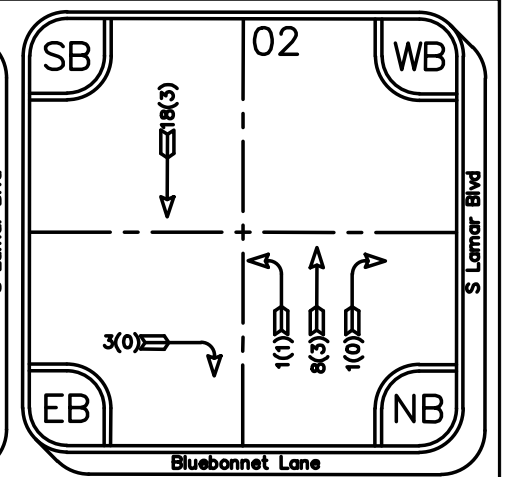
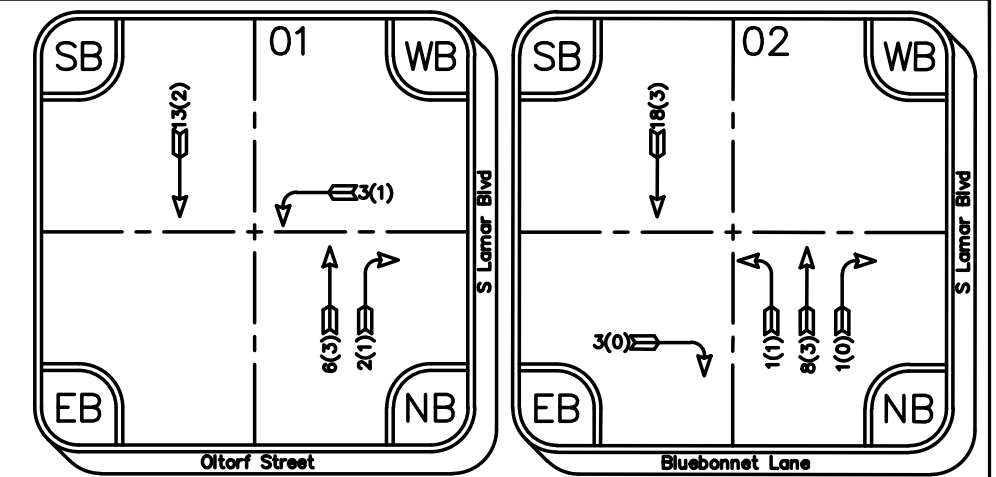
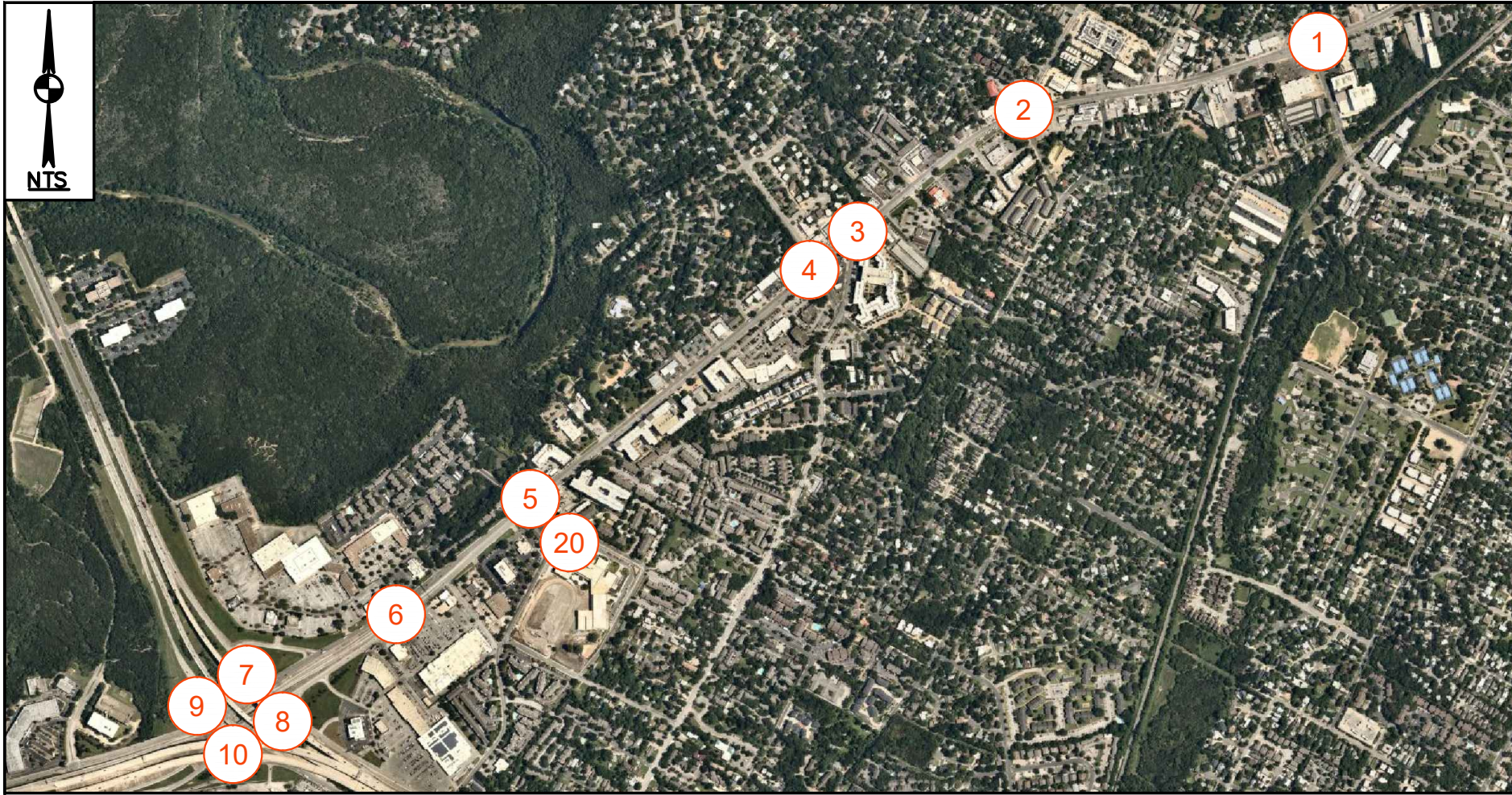

**LEGEND**  
 # STUDY INTERSECTION  
 ##(##) AM(PM) PEAK HOUR VOLUME

FIGURE 2B  
 BACKGROUND VOLUME  
 (AISD ANN RICHARDS SCHOOL)  
 AM & PM PEAK HOUR

**BOE** Consulting Services, LLC  
 9901 Brodie Lane 160-303  
 Austin, Texas 78748  
 Tel. (512) 632-7509  
 TBPE Registration Number F-19220



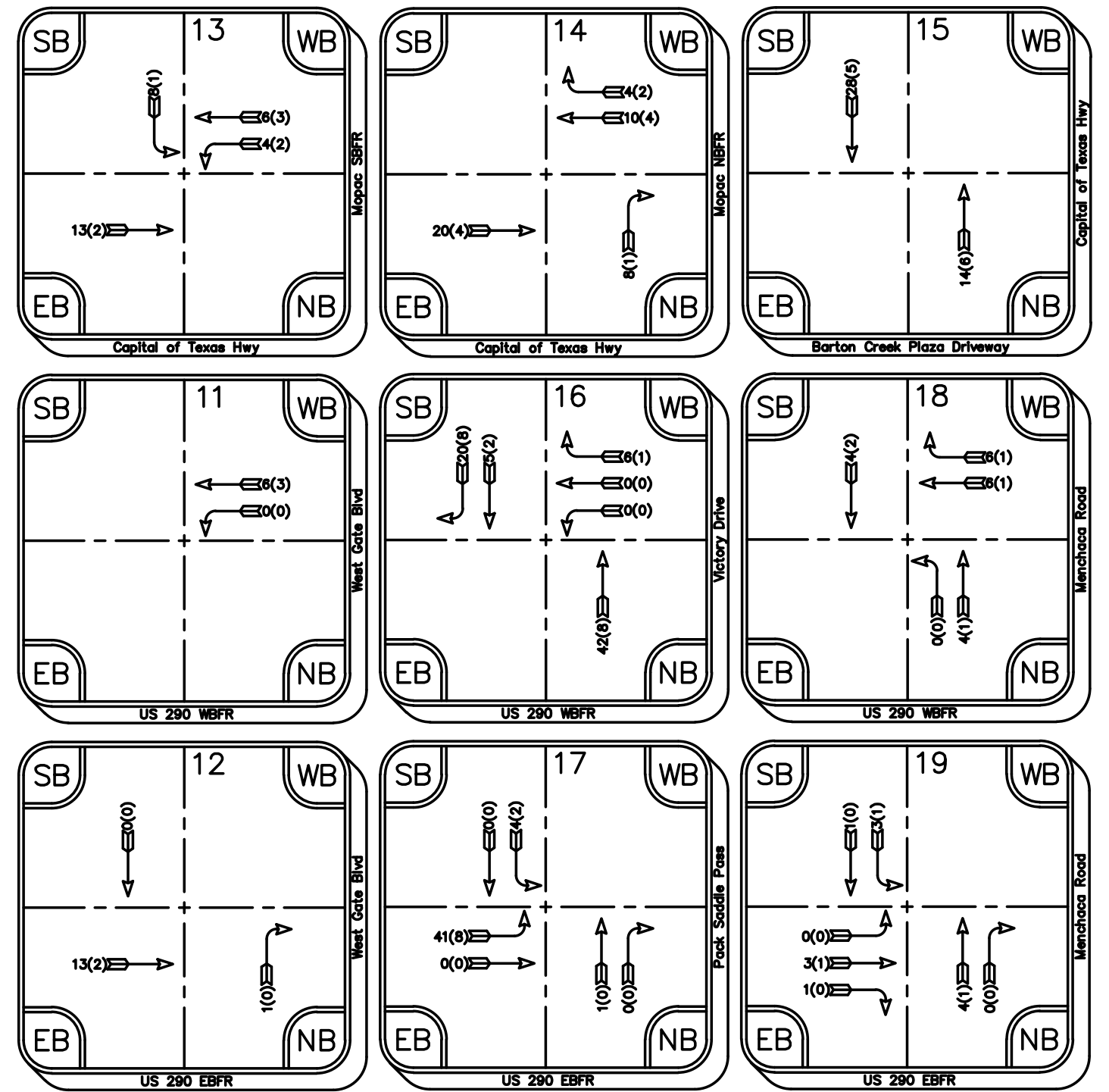
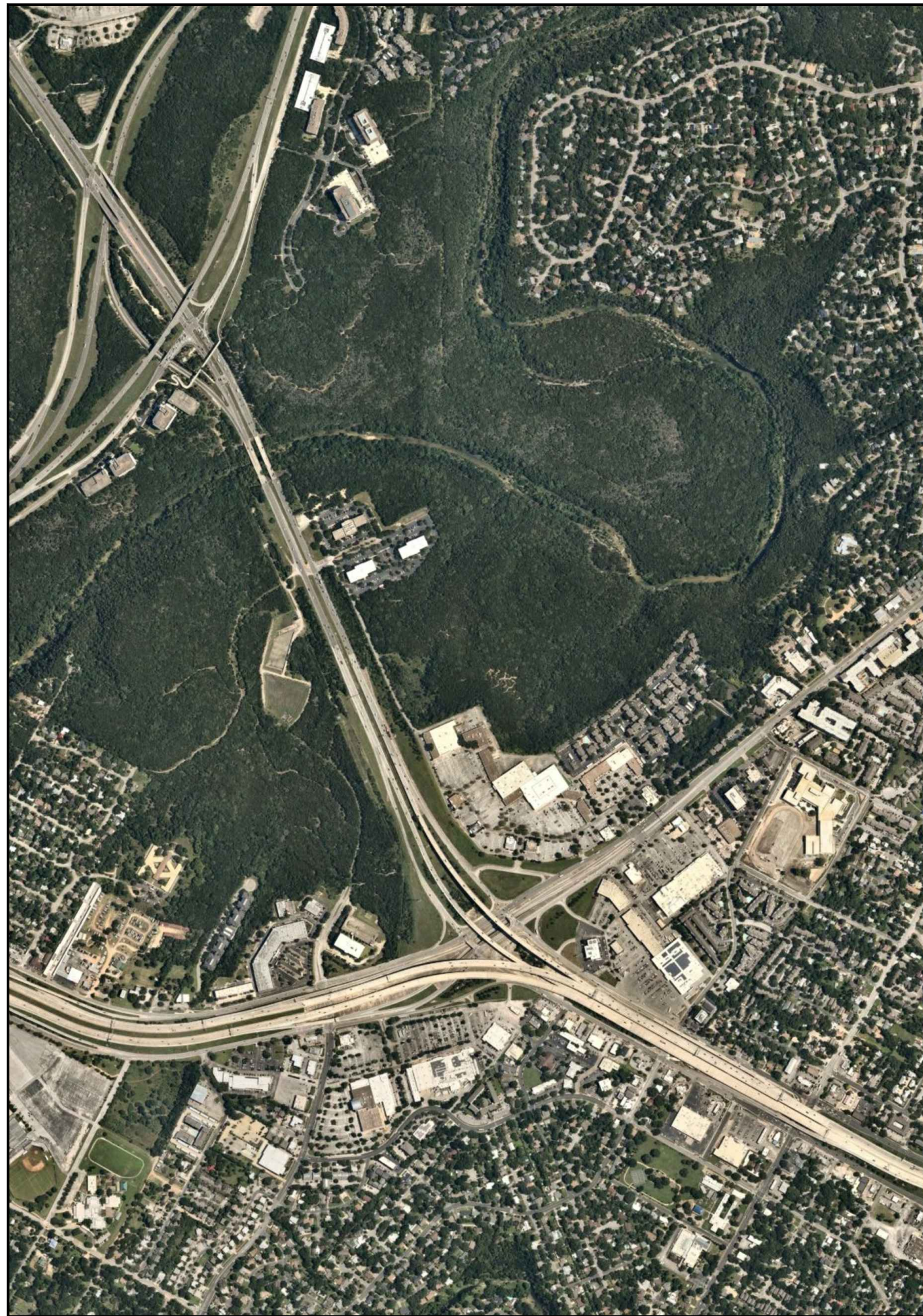

**LEGEND**  
 # STUDY INTERSECTION  
 ##(##) AM(PM) PEAK HOUR VOLUME

FIGURE 2B  
 BACKGROUND VOLUME  
 (AISD ANN RICHARDS SCHOOL)  
 AM & PM PEAK HOUR

**BOE** Consulting Services, LLC  
 9901 Brodie Lane 160-303  
 Austin, Texas 78748  
 Tel. (512) 632-7509  
 TBPE Registration Number F-19220



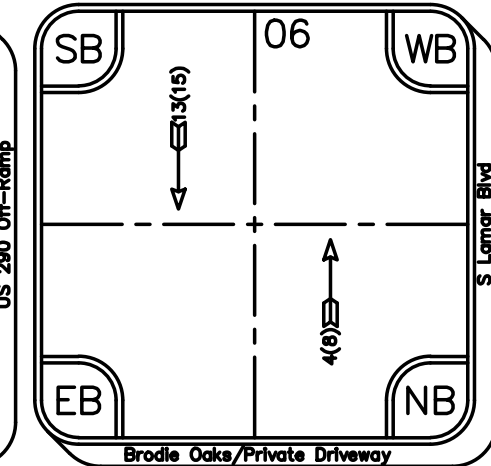
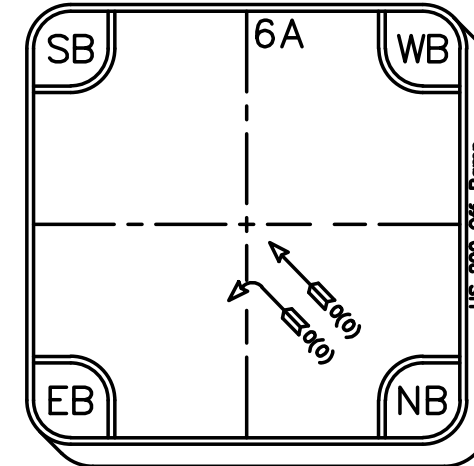
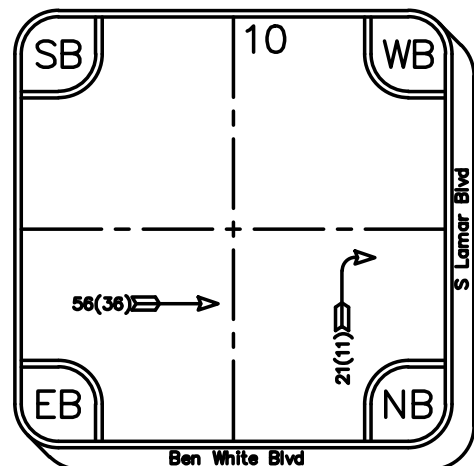
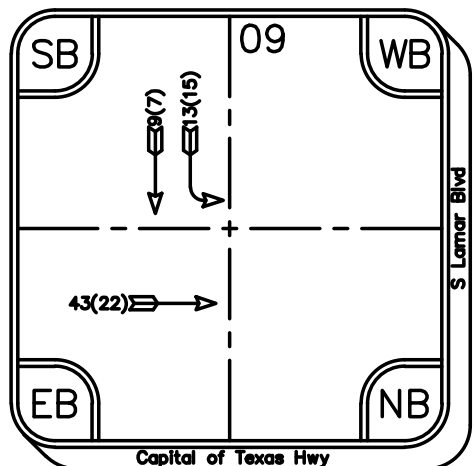
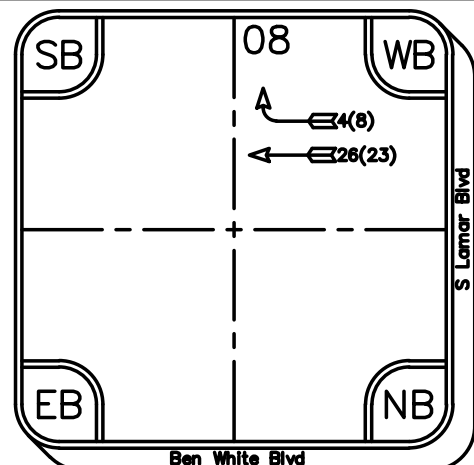
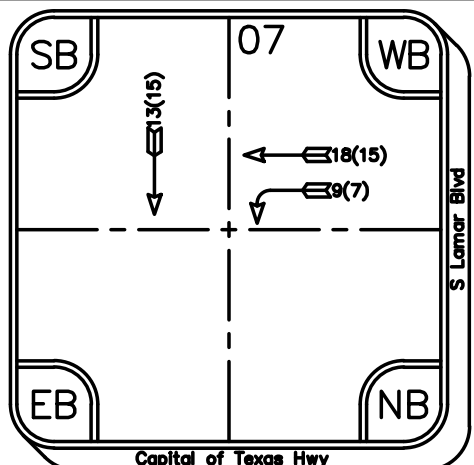
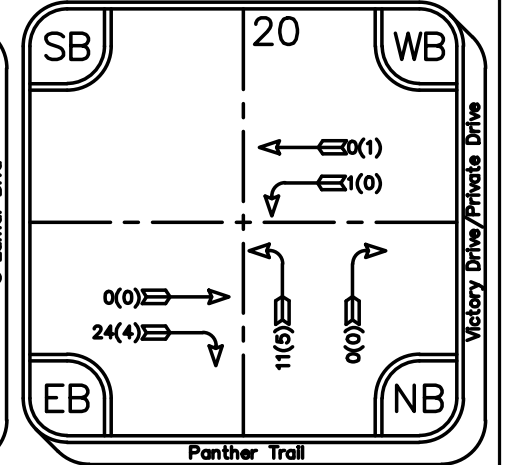
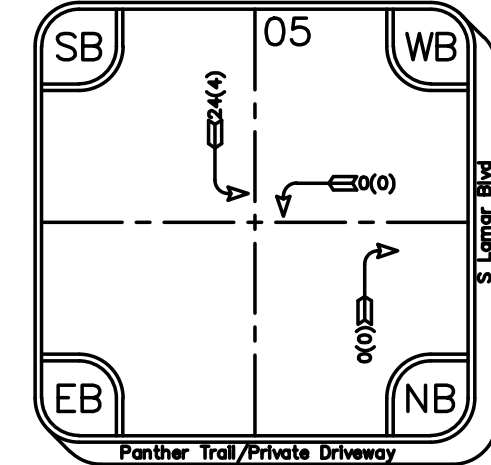
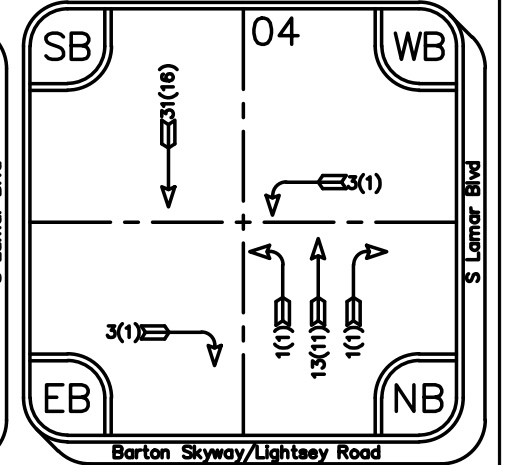
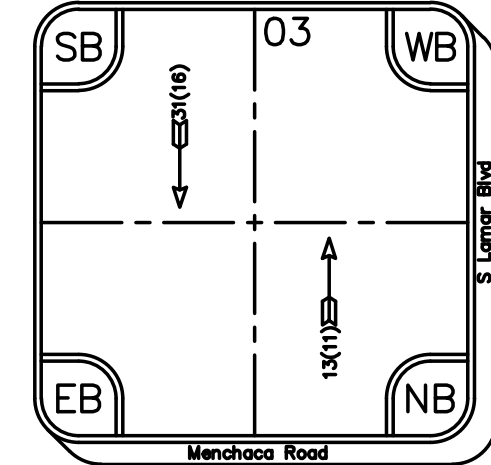
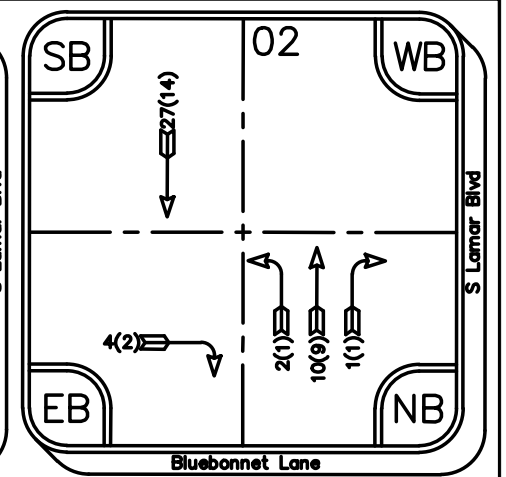
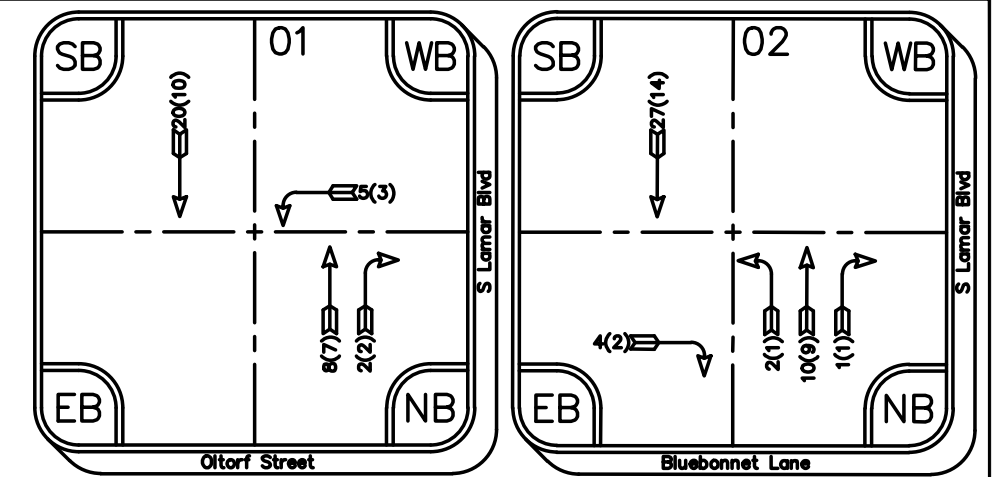
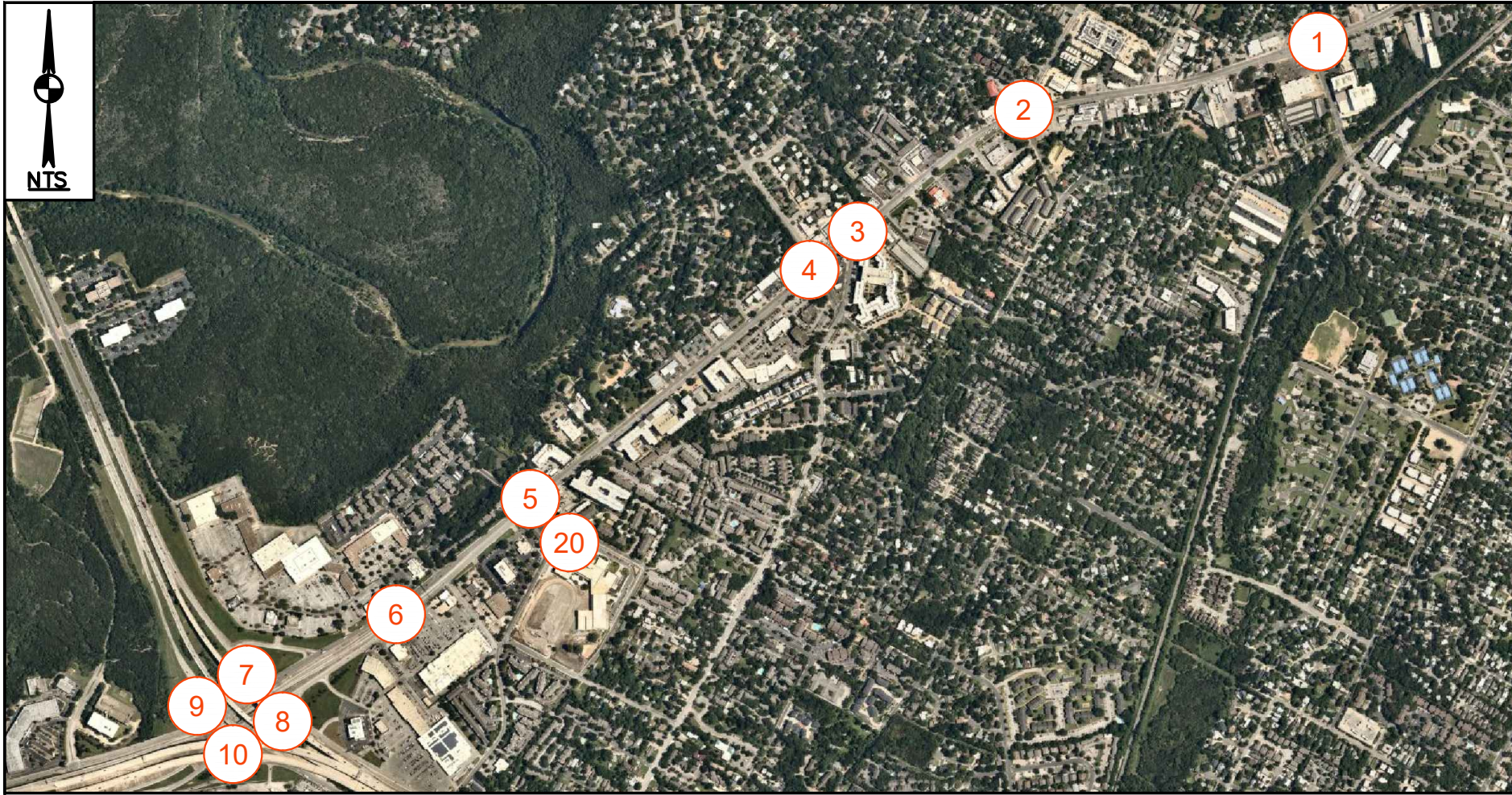

**LEGEND**  
 # STUDY INTERSECTION  
 ##(##) AM(PM) PEAK HOUR VOLUME

FIGURE 2C  
 BACKGROUND VOLUME  
 (TOTAL)  
 AM & PM PEAK HOUR  
**BOE** Consulting Services, LLC  
 9901 Brodie Lane 160-303  
 Austin, Texas 78748  
 Tel. (512) 632-7509  
 TBPE Registration Number F-19220



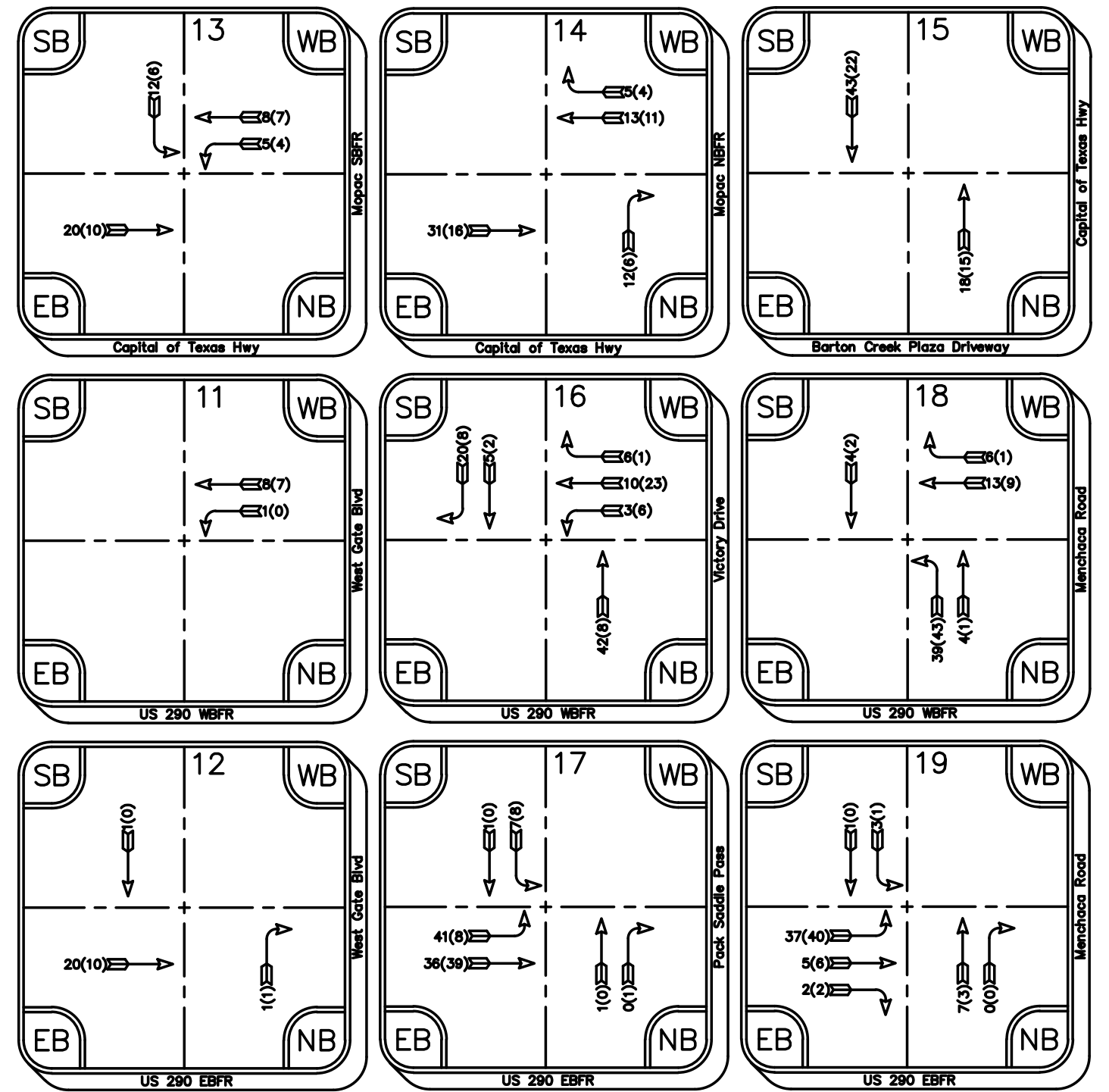
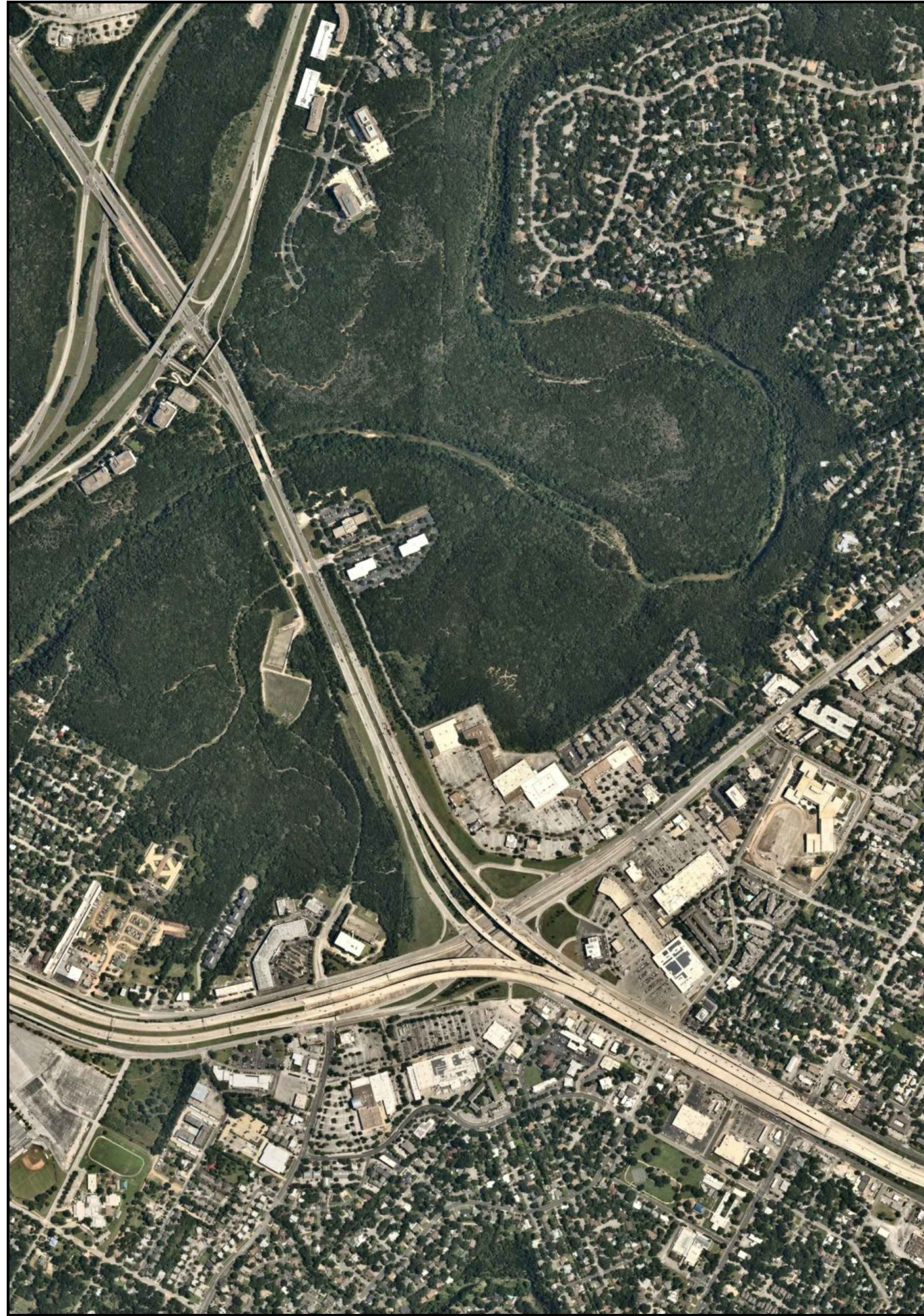

**LEGEND**

# STUDY INTERSECTION  
 ##(##) AM(PM) PEAK HOUR VOLUME

---

FIGURE 2C  
 BACKGROUND VOLUME  
 (TOTAL)  
 AM & PM PEAK HOUR

**BOE** Consulting Services, LLC  
 9901 Brodie Lane 160-303  
 Austin, Texas 78748  
 Tel. (512) 632-7509  
 TBPE Registration Number F-19220



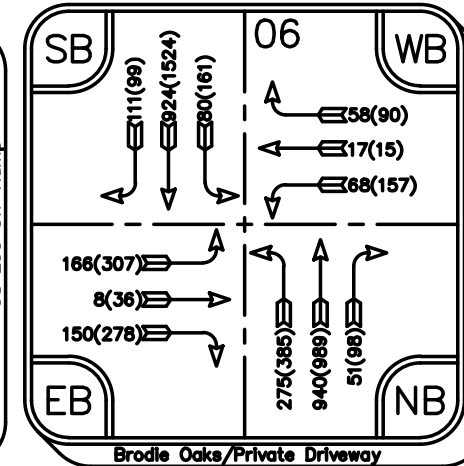
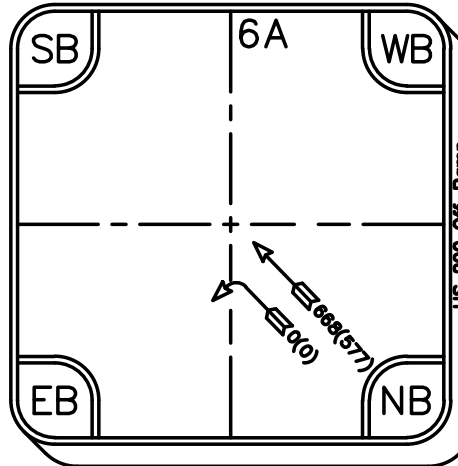
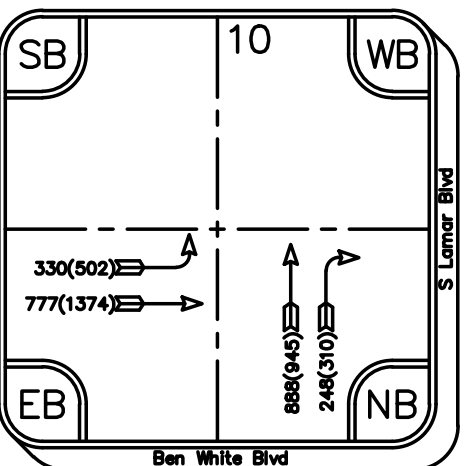
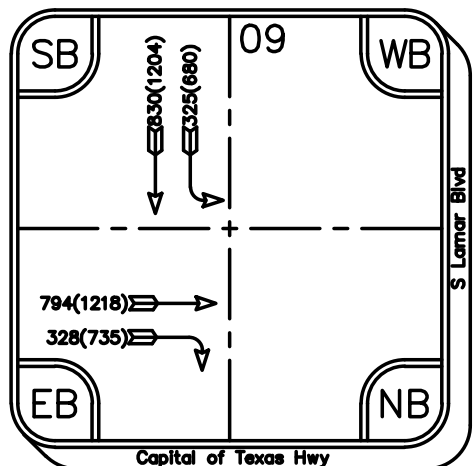
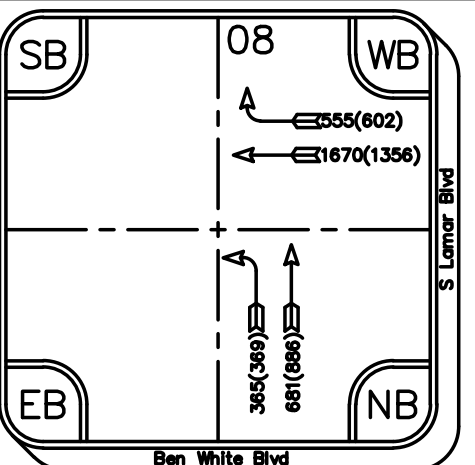
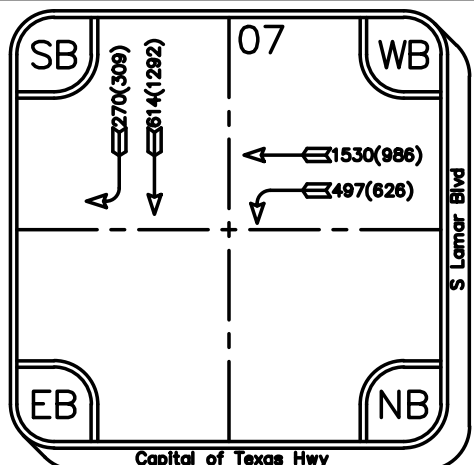
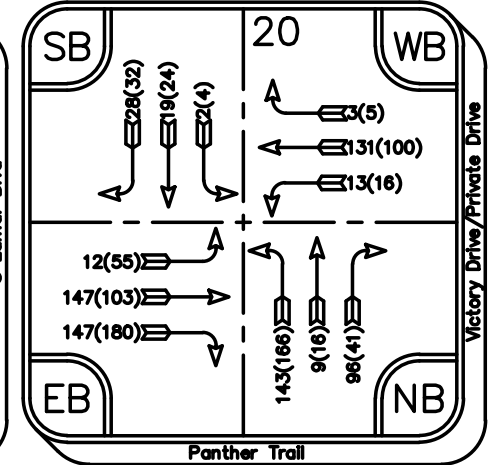
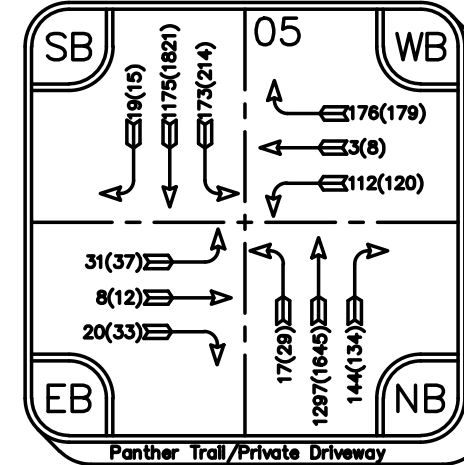
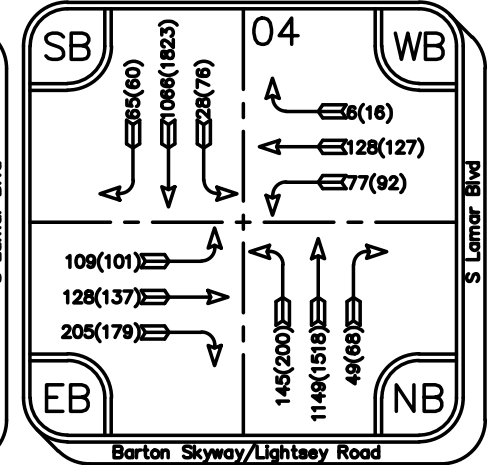
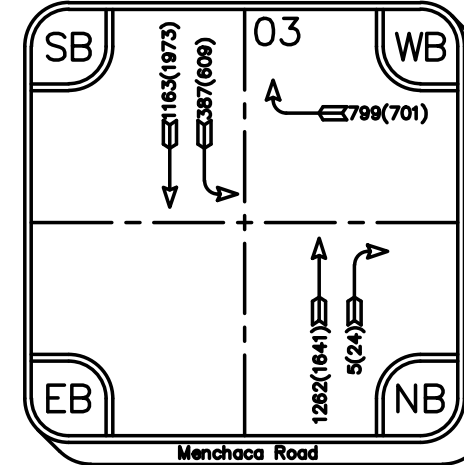
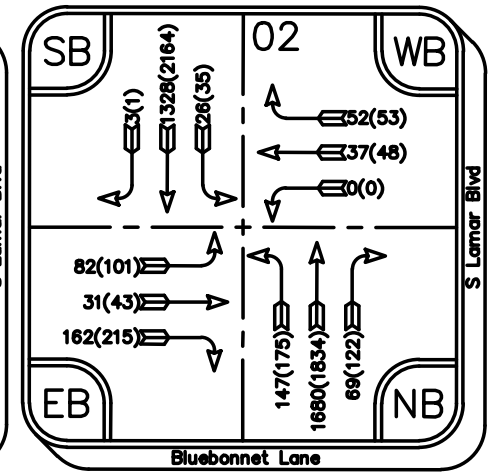
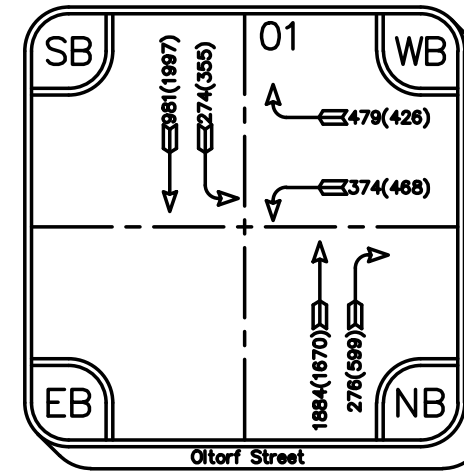
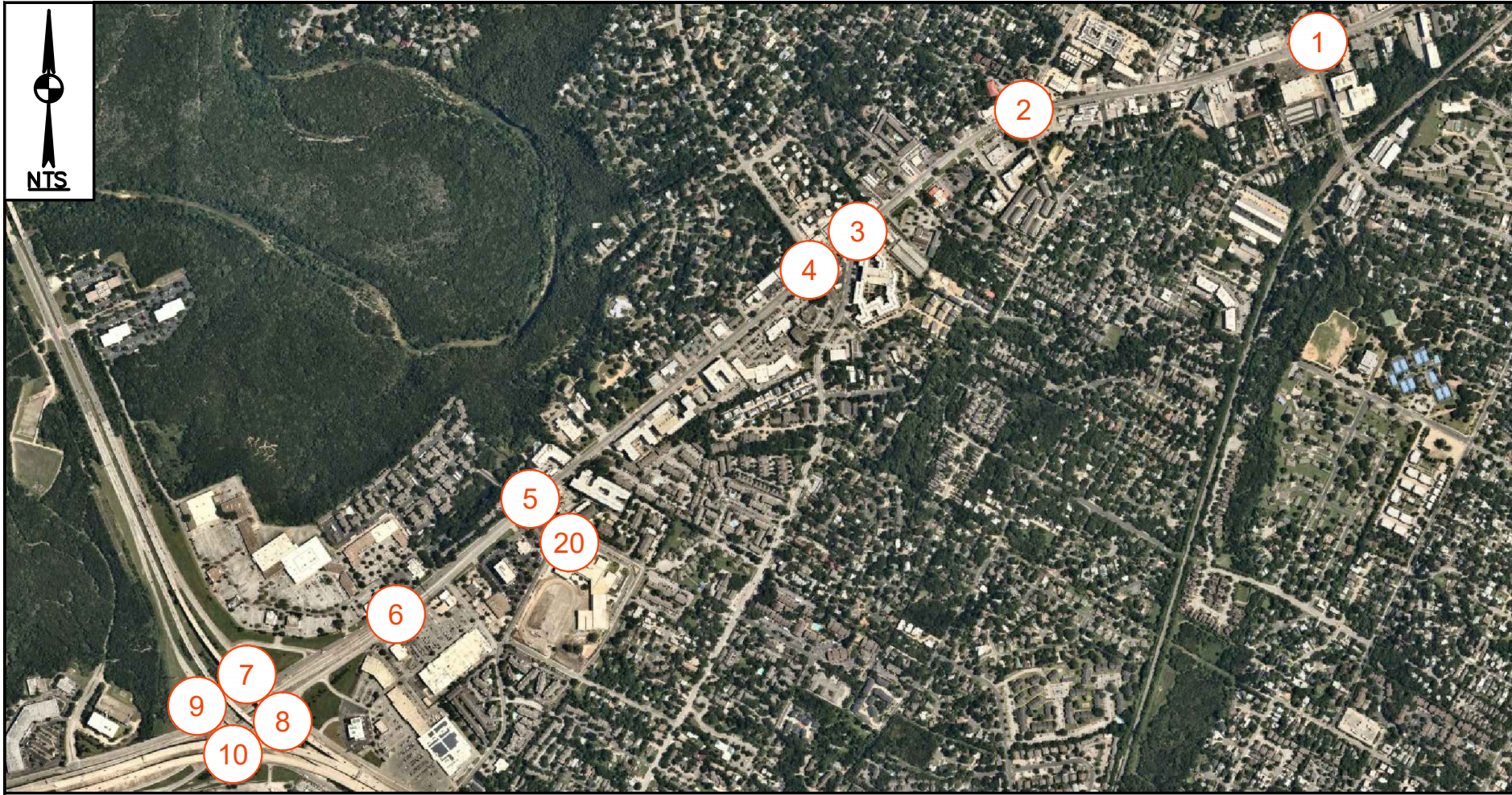

**LEGEND**  
 # STUDY INTERSECTION  
 ##(##) AM(PM) PEAK HOUR VOLUME

**FIGURE 3**  
 PHASE 1  
 2026 FORECASTED  
 AM & PM PEAK HOUR  
**BOE** Consulting Services, LLC  
 9901 Brodie Lane 160-303  
 Austin, Texas 78748  
 Tel. (512) 632-7509  
 TBPE Registration Number F-19220



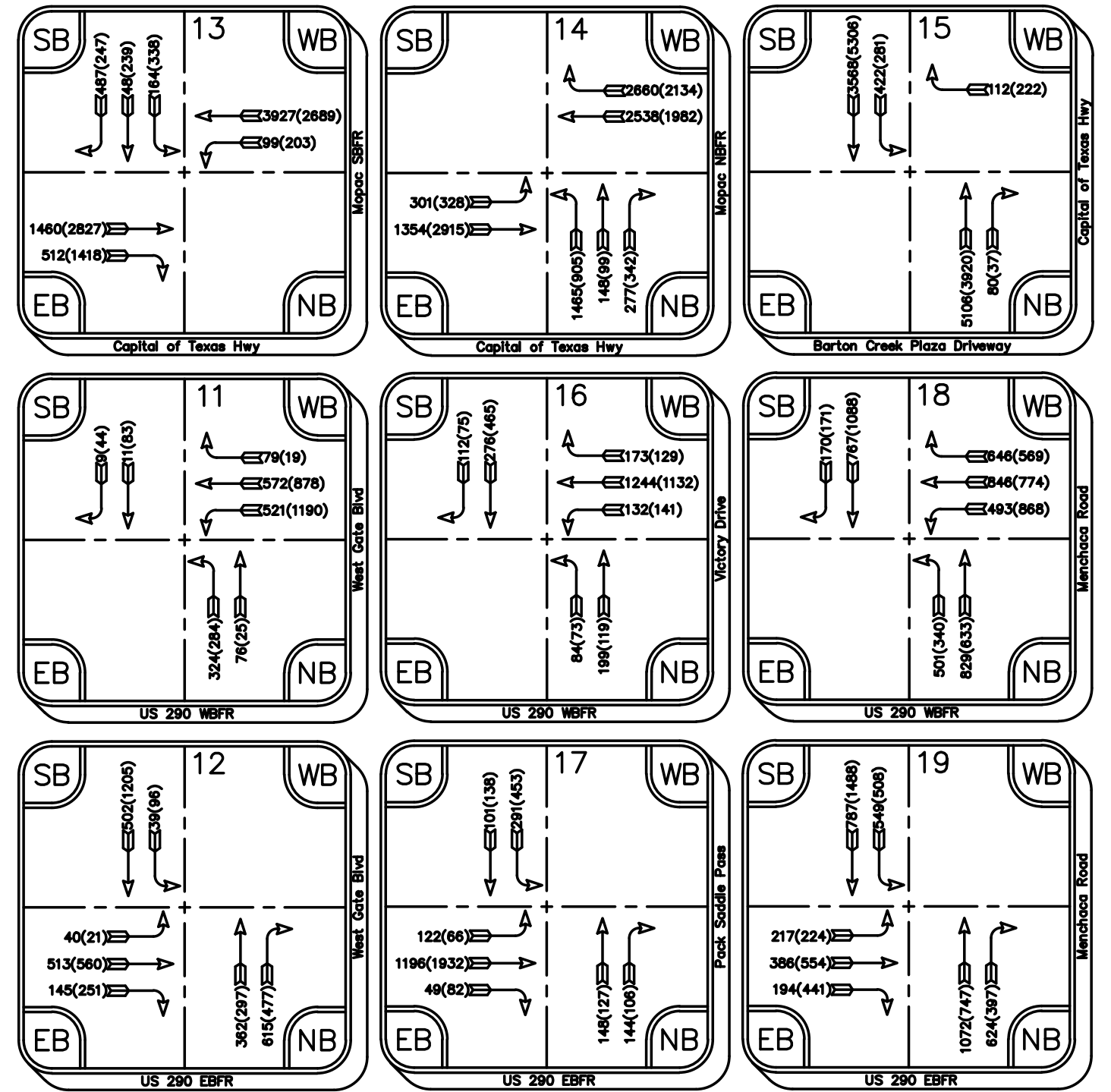
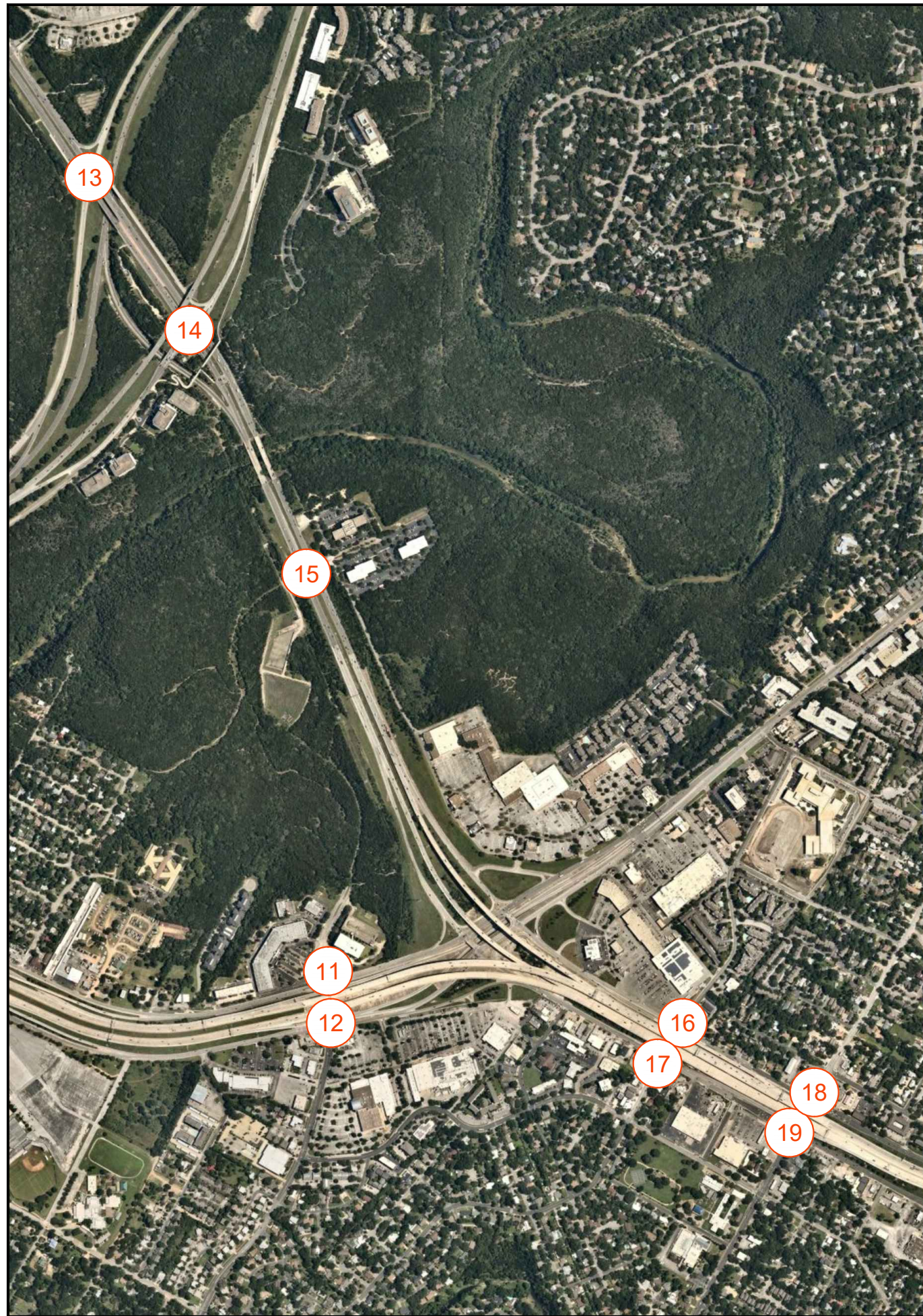

**LEGEND**

- ⊙ STUDY INTERSECTION
- ##(##) AM(PM) PEAK HOUR VOLUME

FIGURE 3  
 PHASE 1  
 2026 FORECASTED  
 AM & PM PEAK HOUR

**BOE** Consulting Services, LLC  
 9901 Brodie Lane 160-303  
 Austin, Texas 78748  
 Tel. (512) 632-7509  
 TBPE Registration Number F-19220



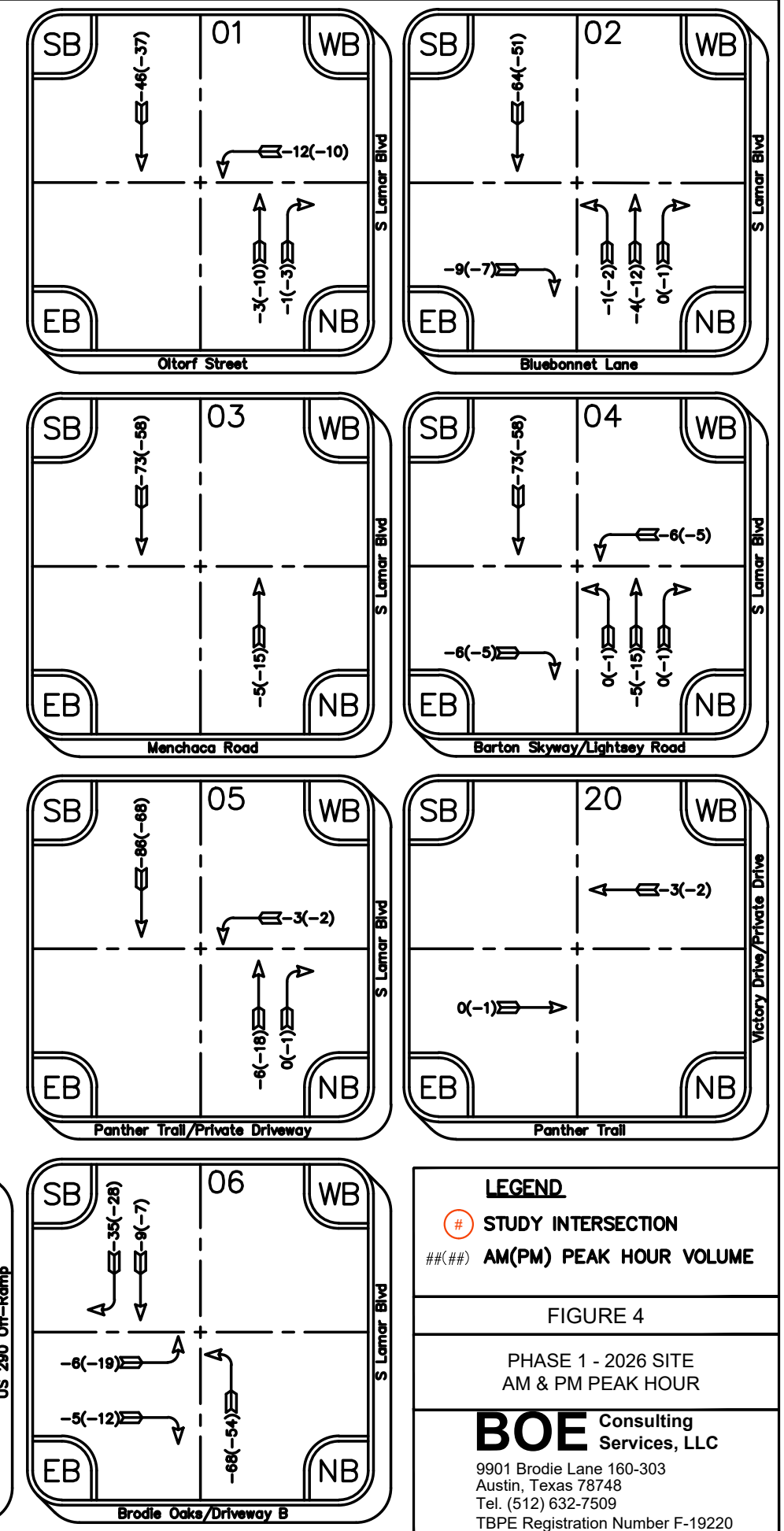
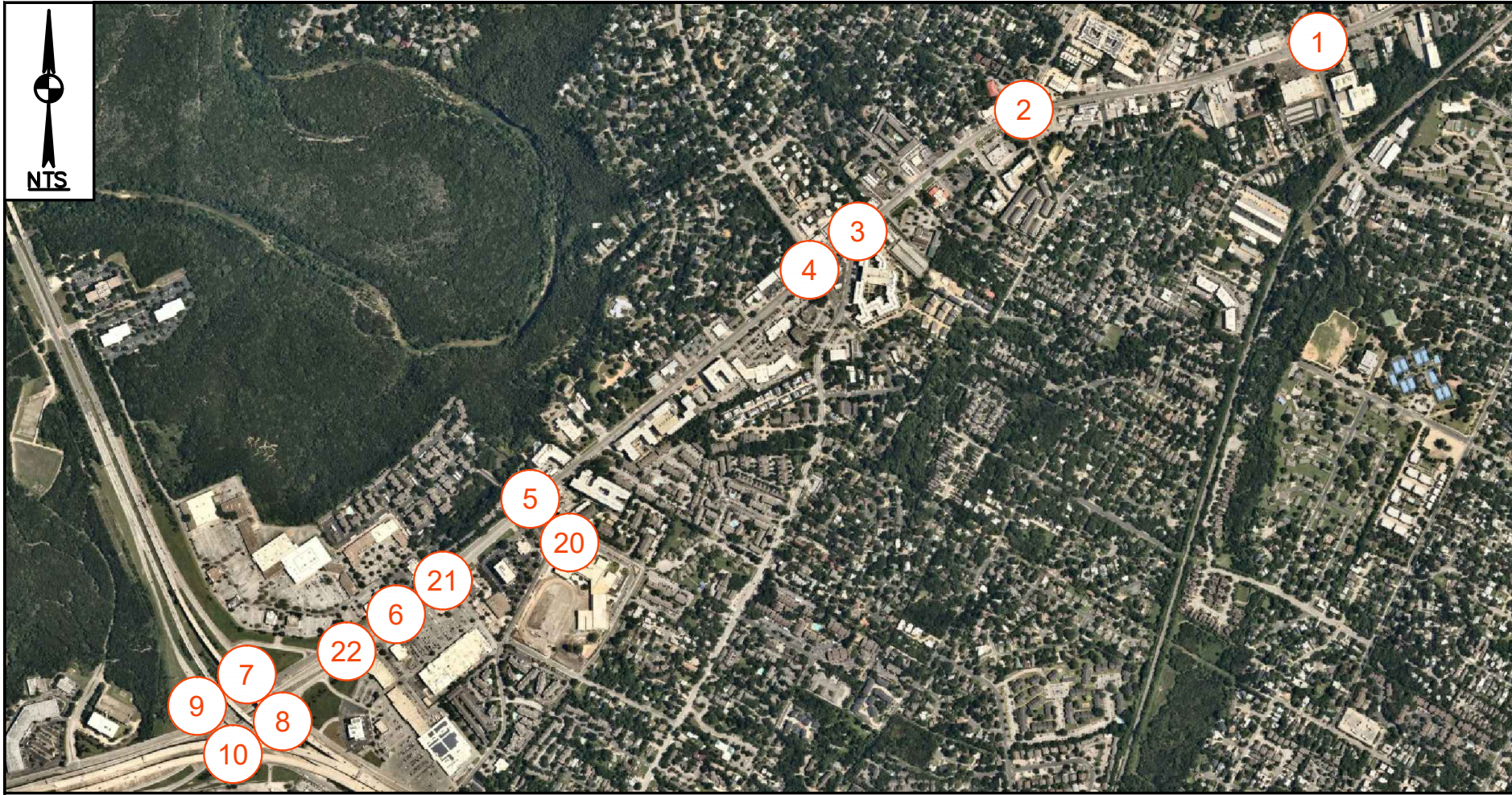

**LEGEND**

- ⊙ STUDY INTERSECTION
- ##(##) AM(PM) PEAK HOUR VOLUME

**FIGURE 4**

PHASE 1 - 2026 SITE  
AM & PM PEAK HOUR

**BOE** Consulting Services, LLC  
 9901 Brodie Lane 160-303  
 Austin, Texas 78748  
 Tel. (512) 632-7509  
 TBPE Registration Number F-19220



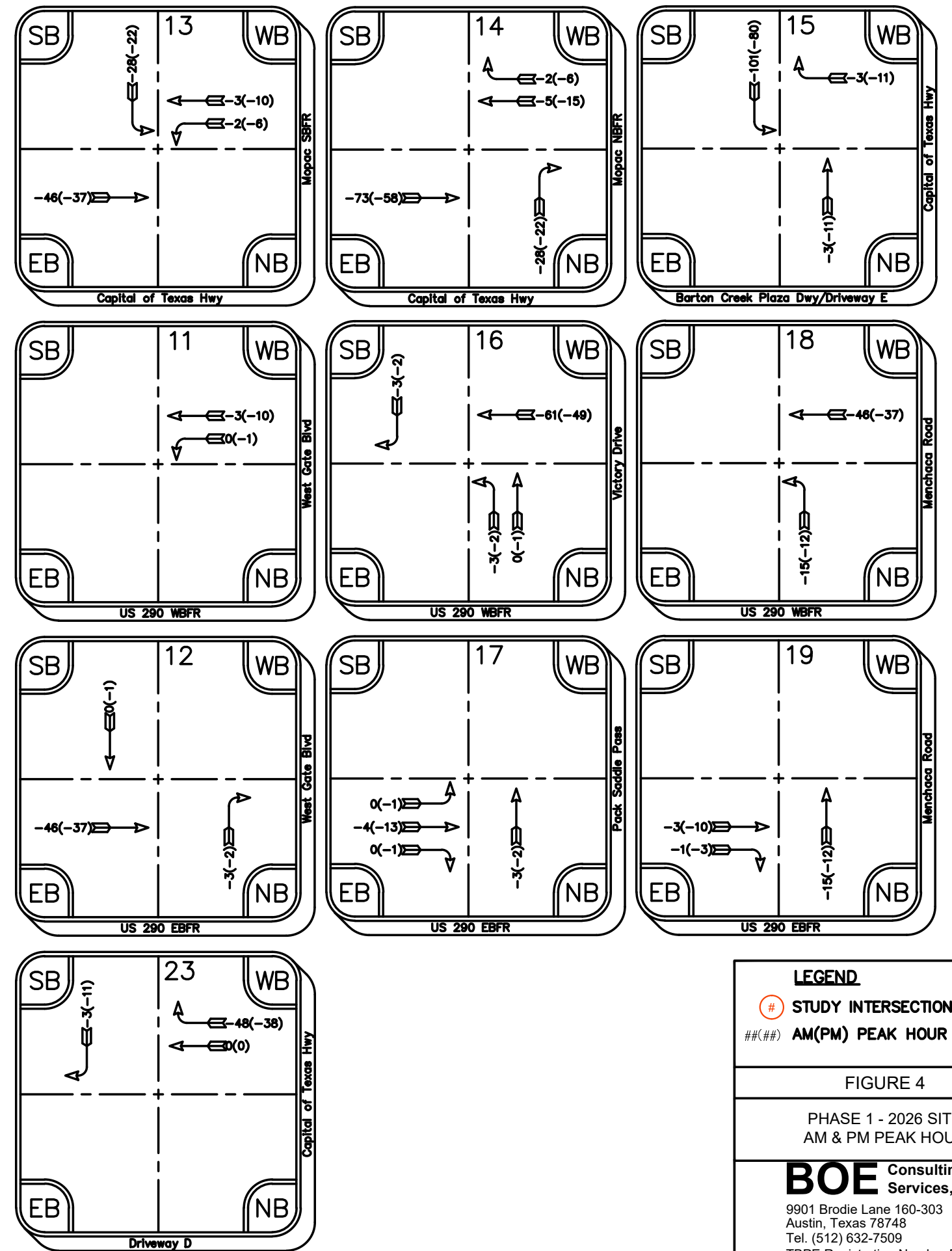
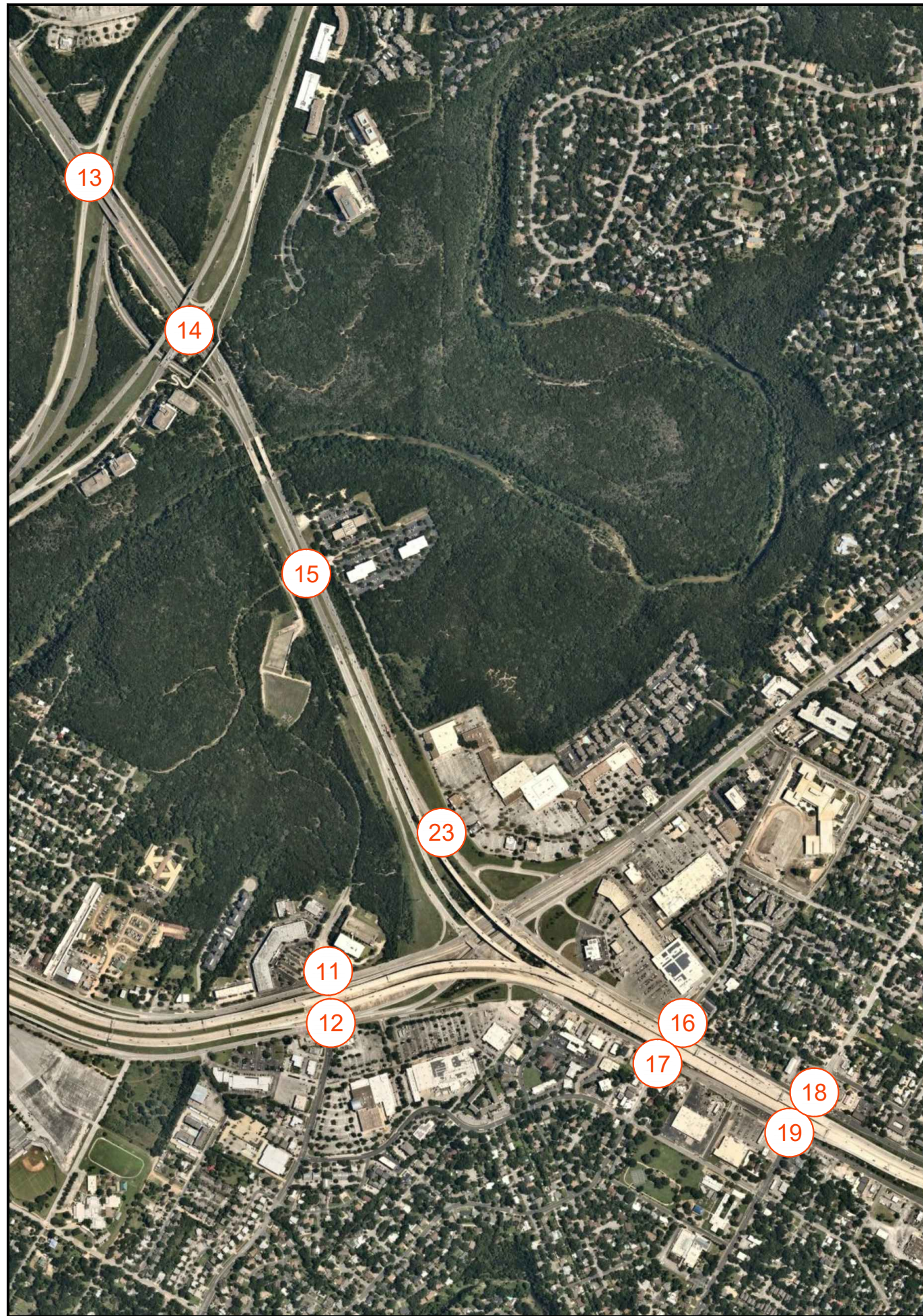



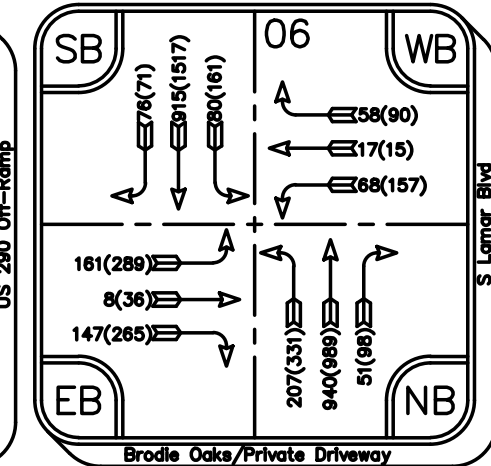
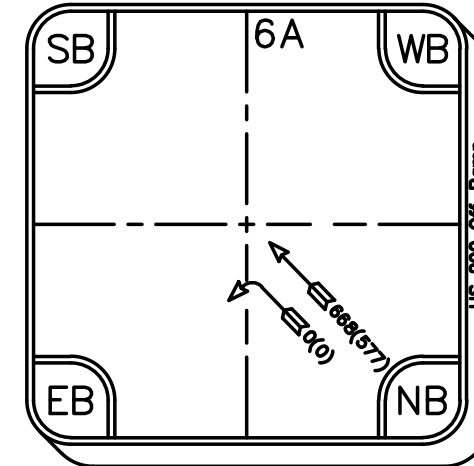
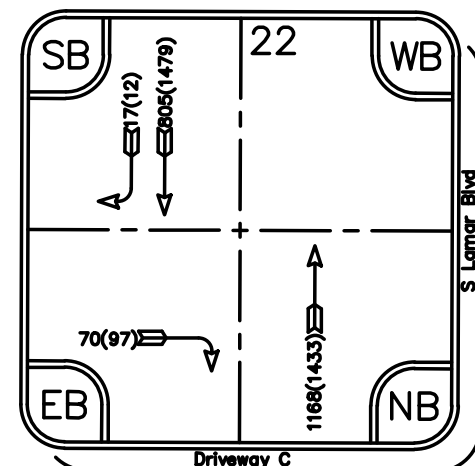
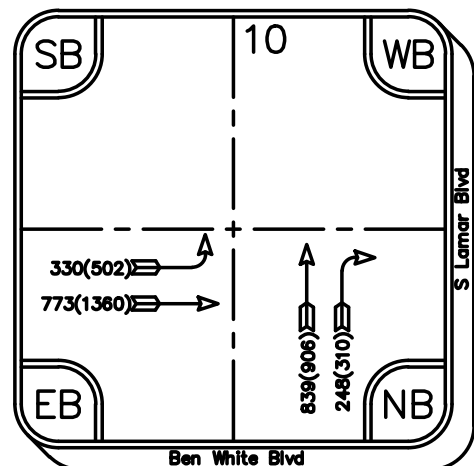
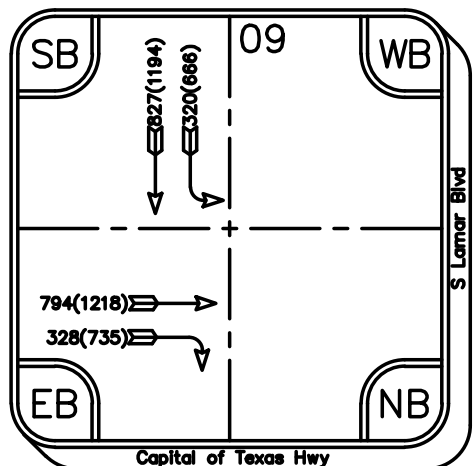
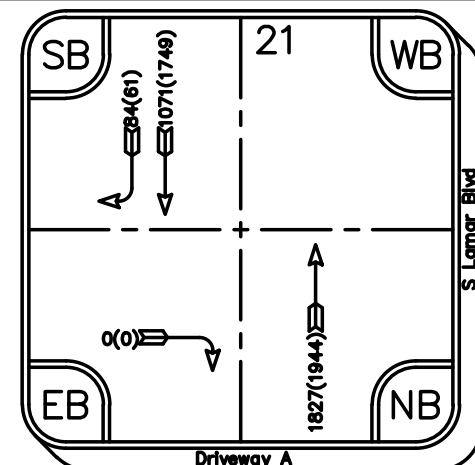
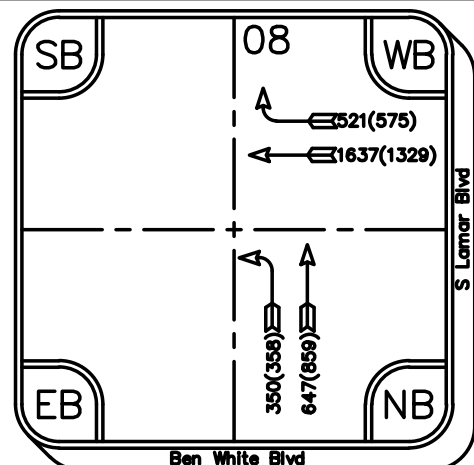
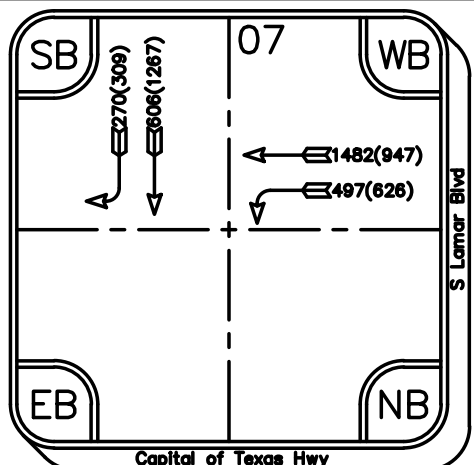
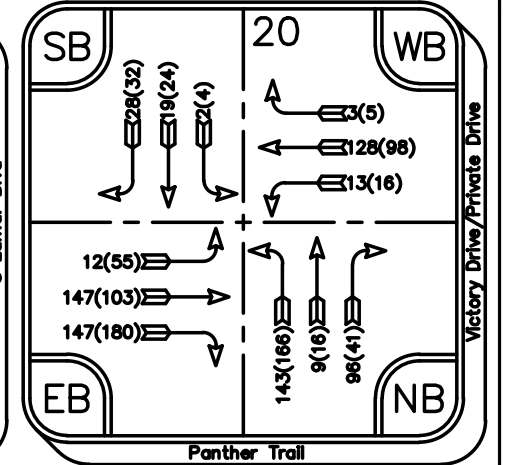
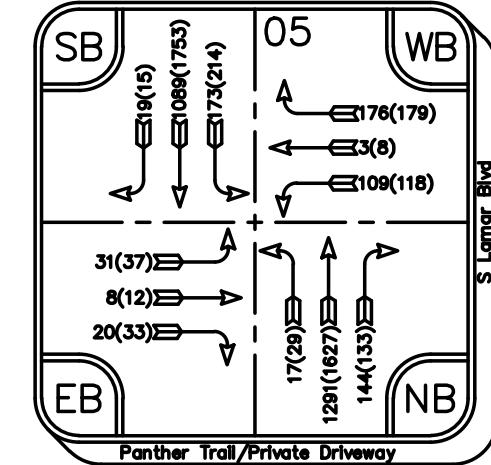
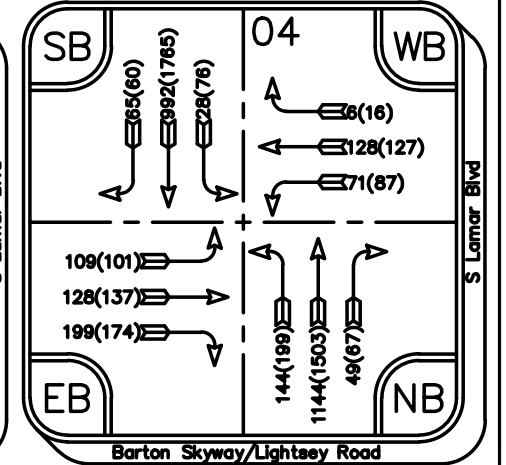
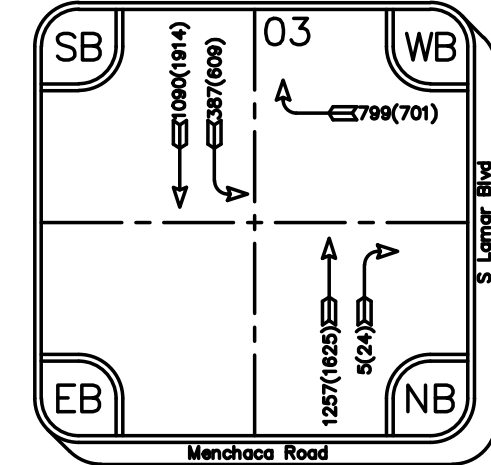
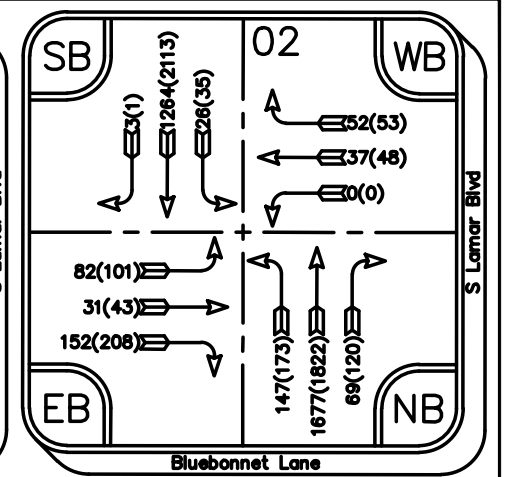
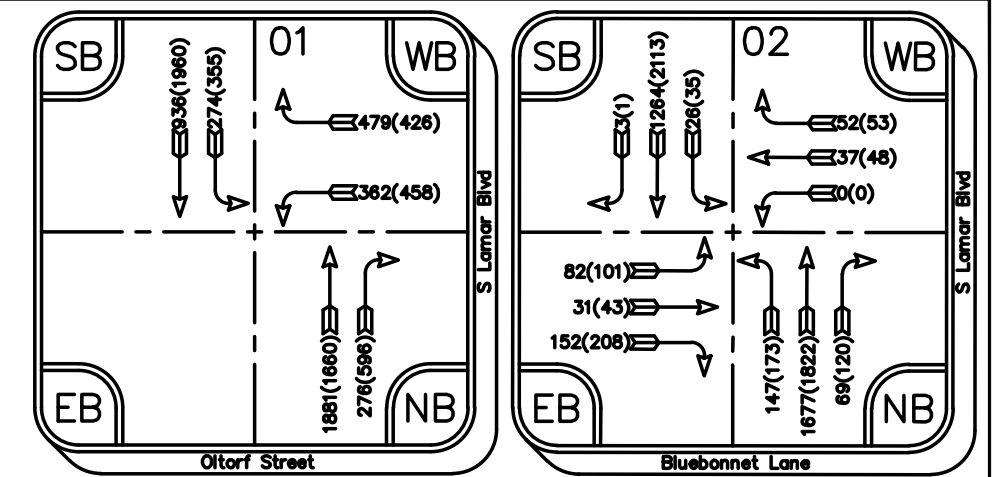
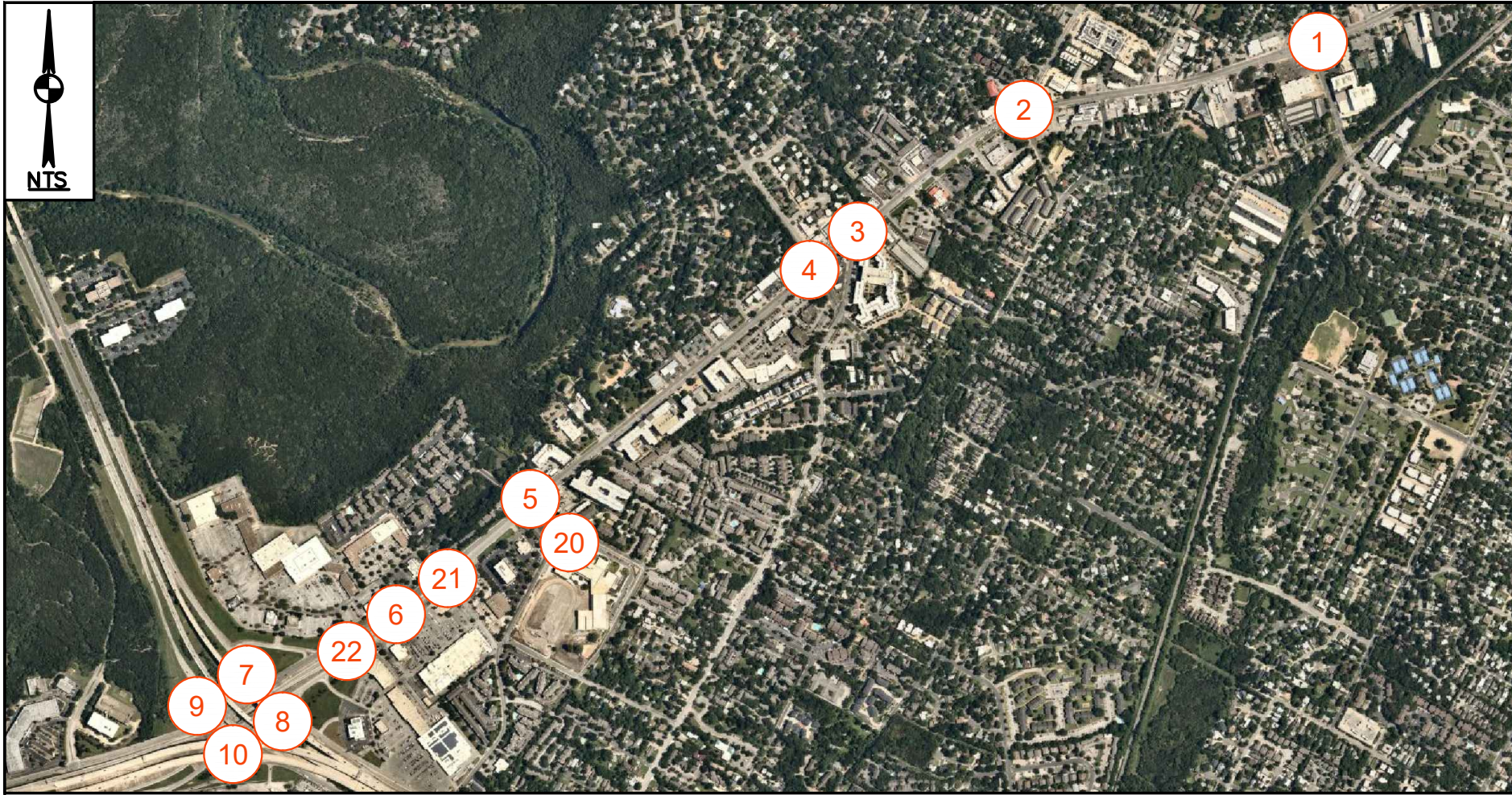

**LEGEND**  
 (0) STUDY INTERSECTION  
 ##(##) AM(PM) PEAK HOUR VOLUME

FIGURE 5  
 PHASE 1  
 2026 SITE+FORECASTED  
 AM & PM PEAK HOUR  
**BOE** Consulting Services, LLC  
 9901 Brodie Lane 160-303  
 Austin, Texas 78748  
 Tel. (512) 632-7509  
 TBPE Registration Number F-19220



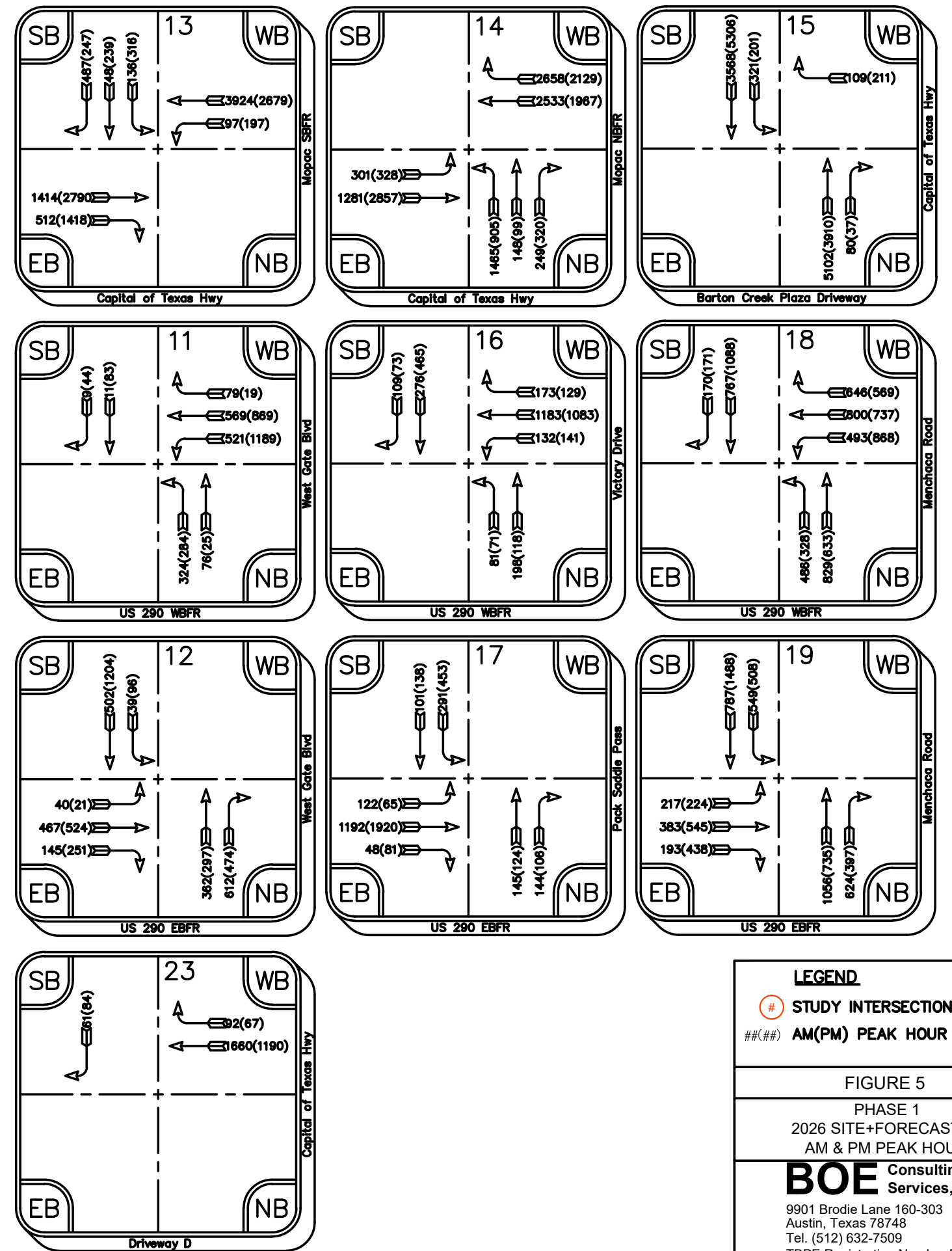
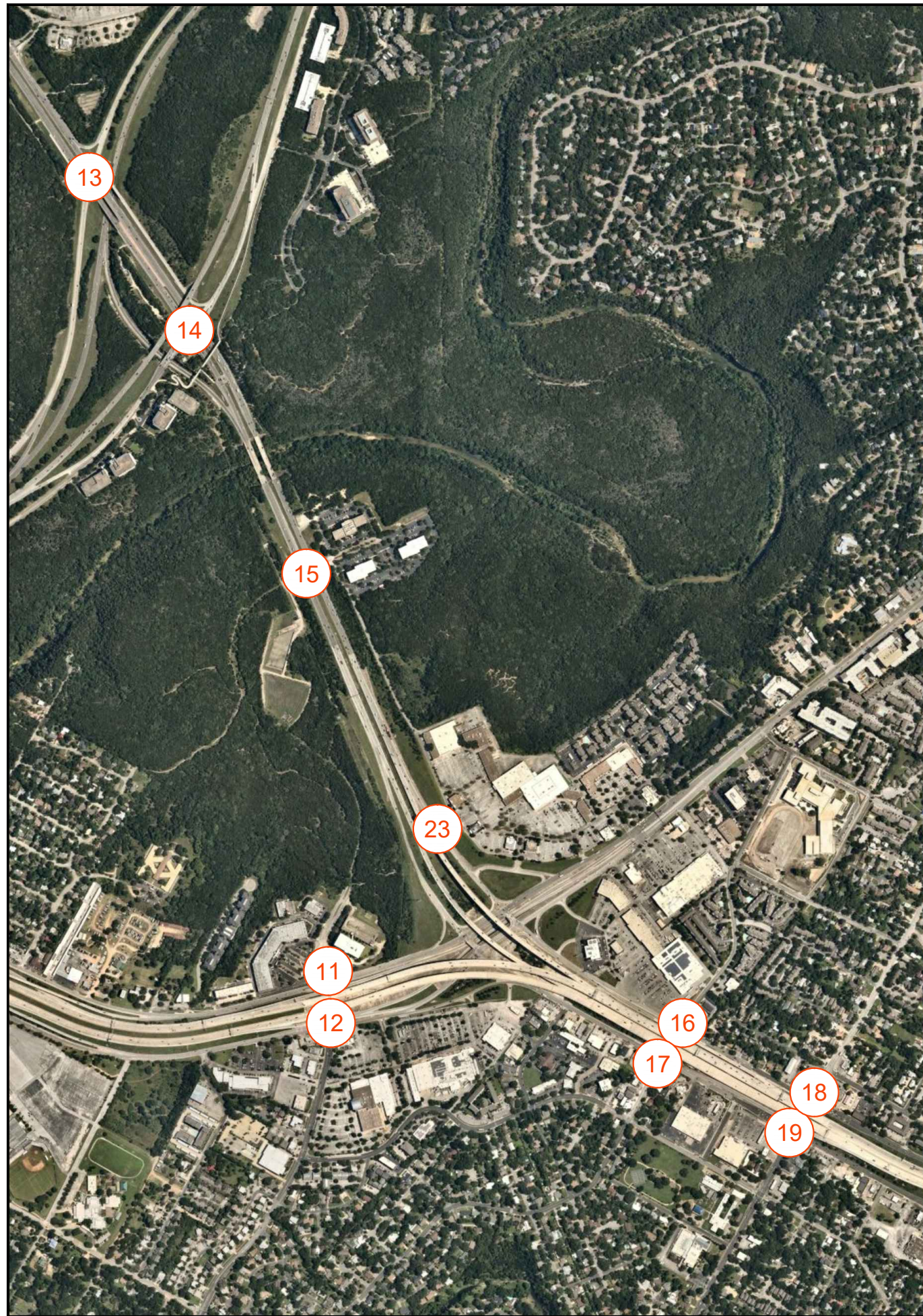

**LEGEND**

- ⊙ STUDY INTERSECTION
- ##(##) AM(PM) PEAK HOUR VOLUME

**FIGURE 5**

PHASE 1  
2026 SITE+FORECASTED  
AM & PM PEAK HOUR

**BOE** Consulting Services, LLC  
9901 Brodie Lane 160-303  
Austin, Texas 78748  
Tel. (512) 632-7509  
TBPE Registration Number F-19220



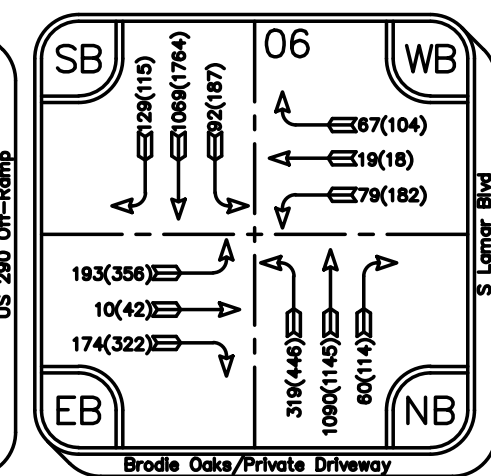
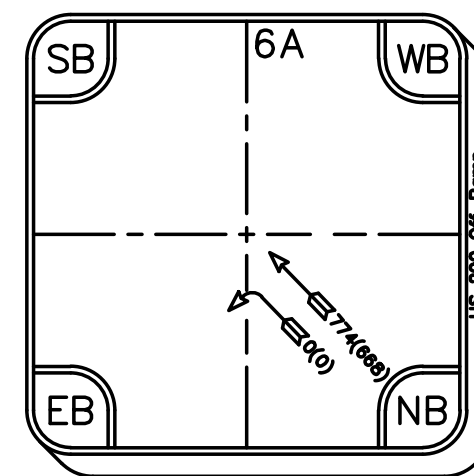
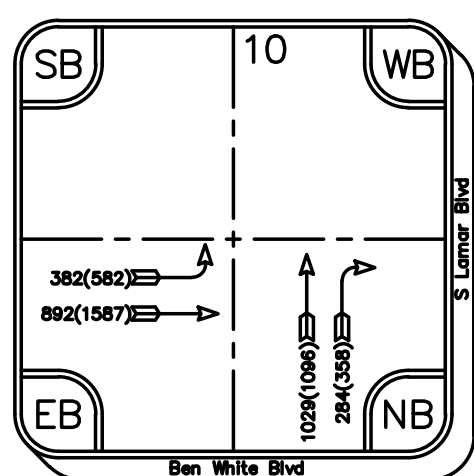
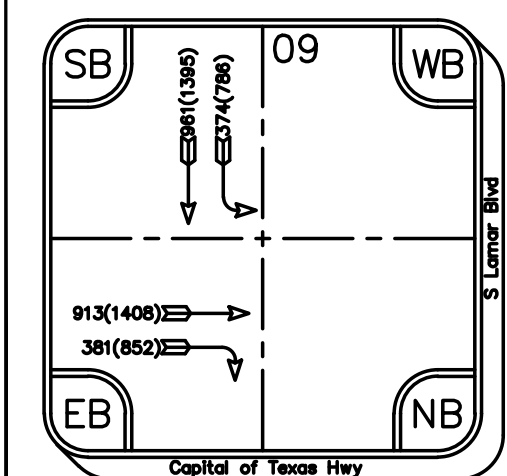
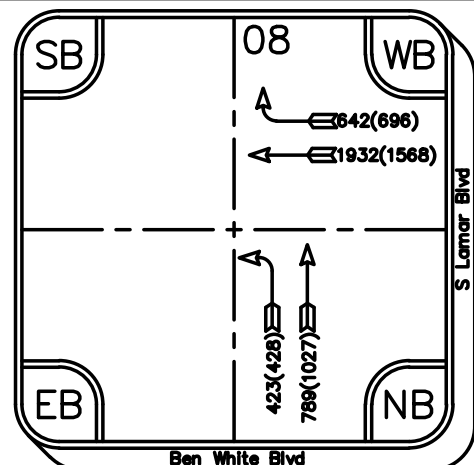
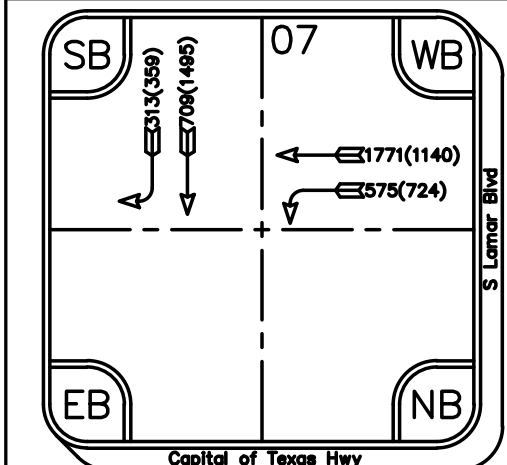
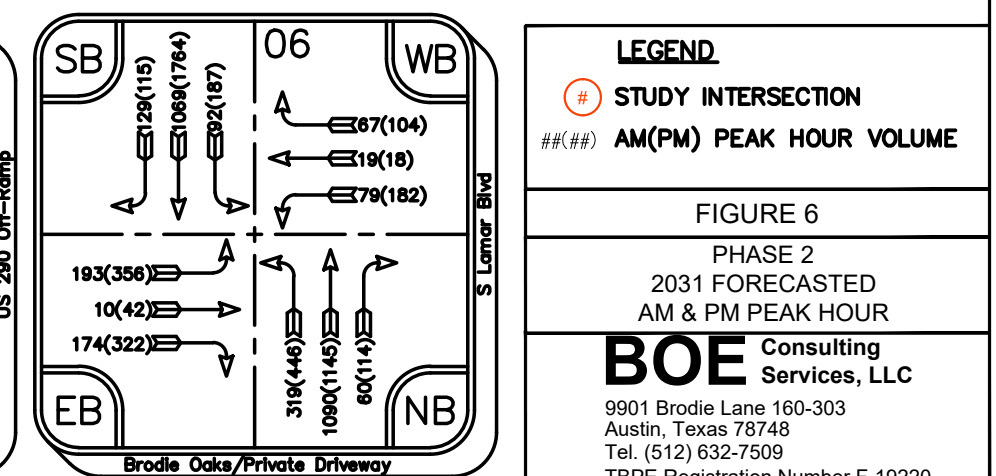
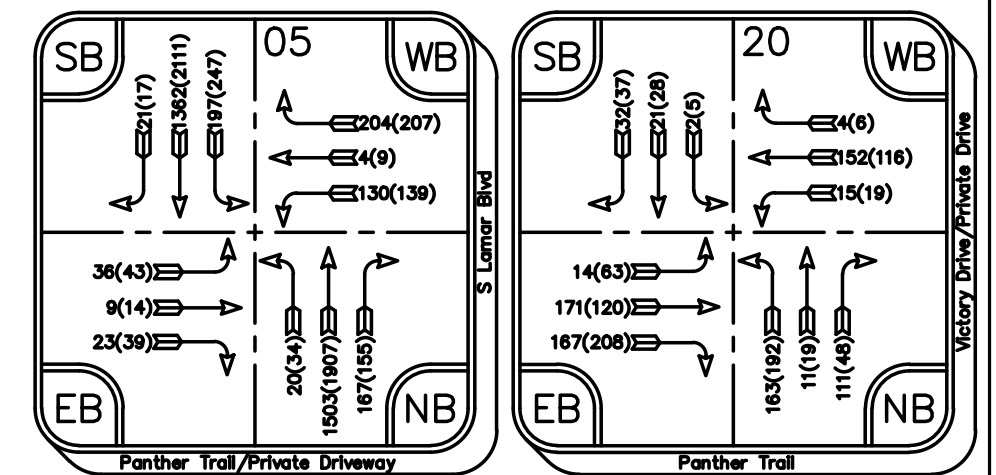
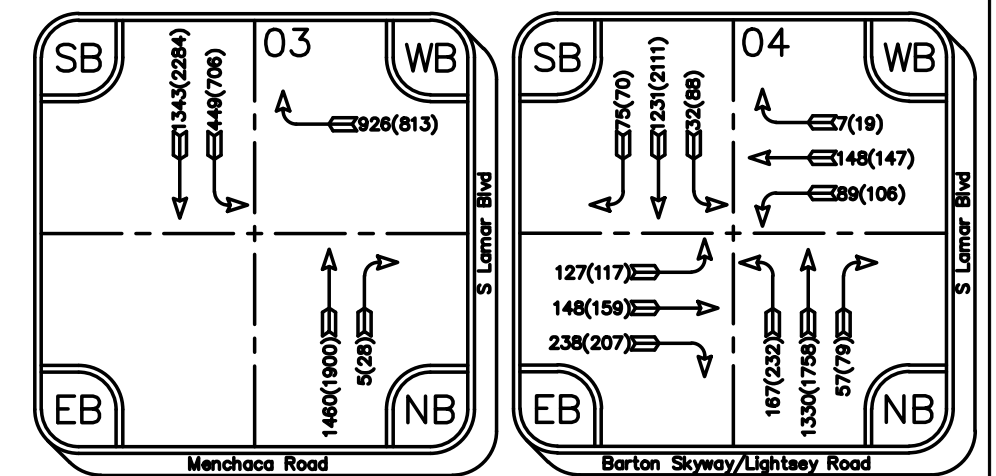
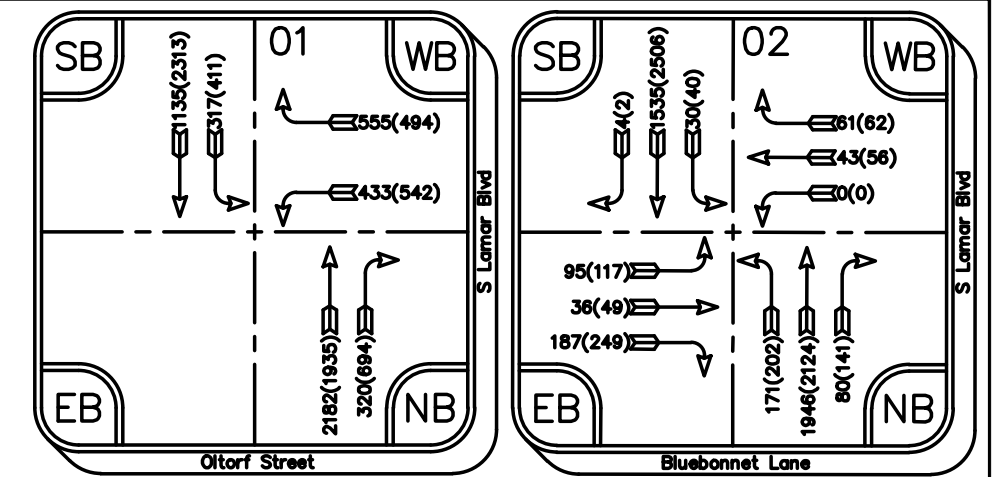
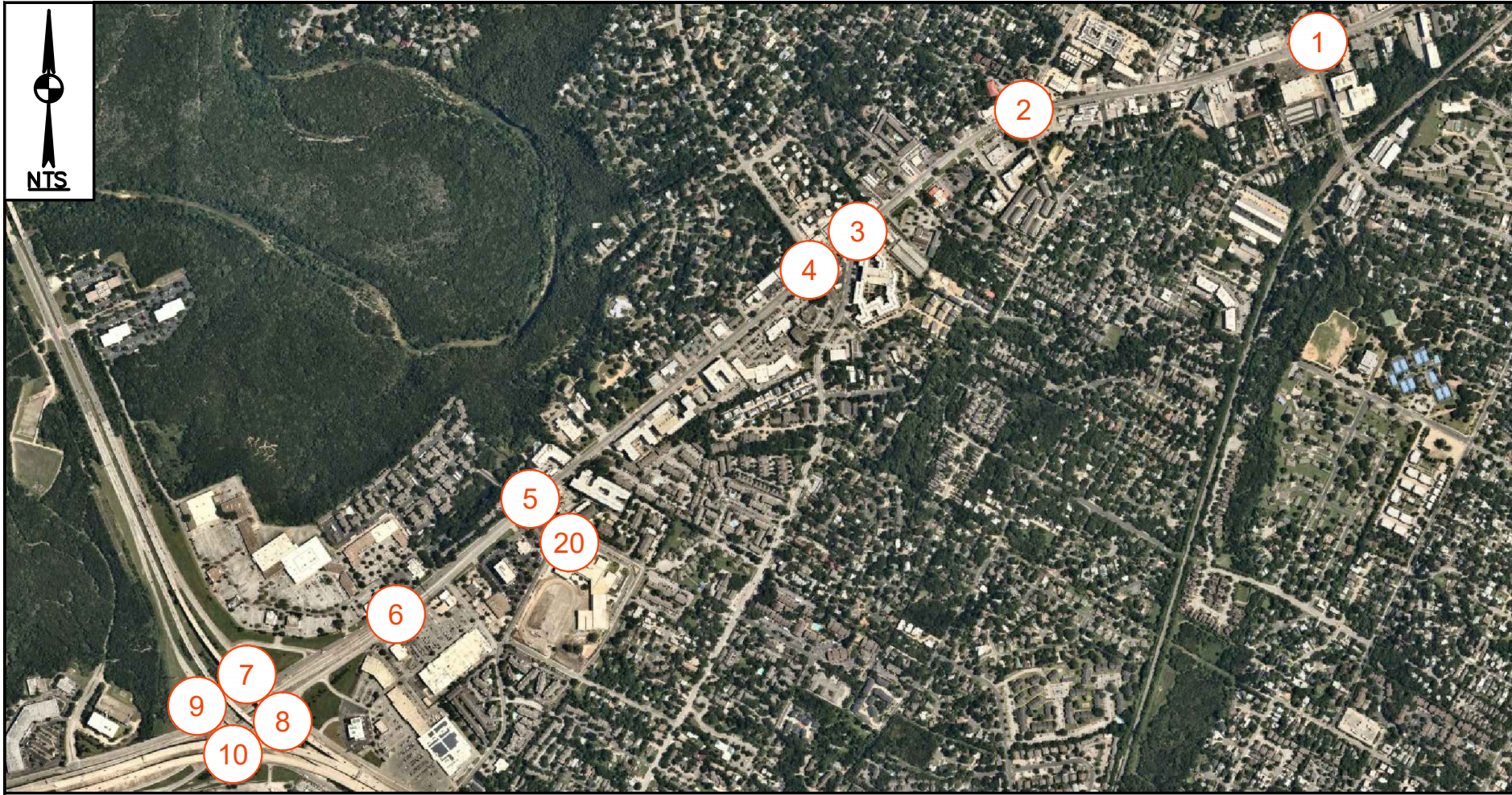

**LEGEND**

- ⊙ STUDY INTERSECTION
- ##(##) AM(PM) PEAK HOUR VOLUME

**FIGURE 6**

PHASE 2  
2031 FORECASTED  
AM & PM PEAK HOUR

**BOE** Consulting Services, LLC

9901 Brodie Lane 160-303  
Austin, Texas 78748  
Tel. (512) 632-7509  
TBPE Registration Number F-19220



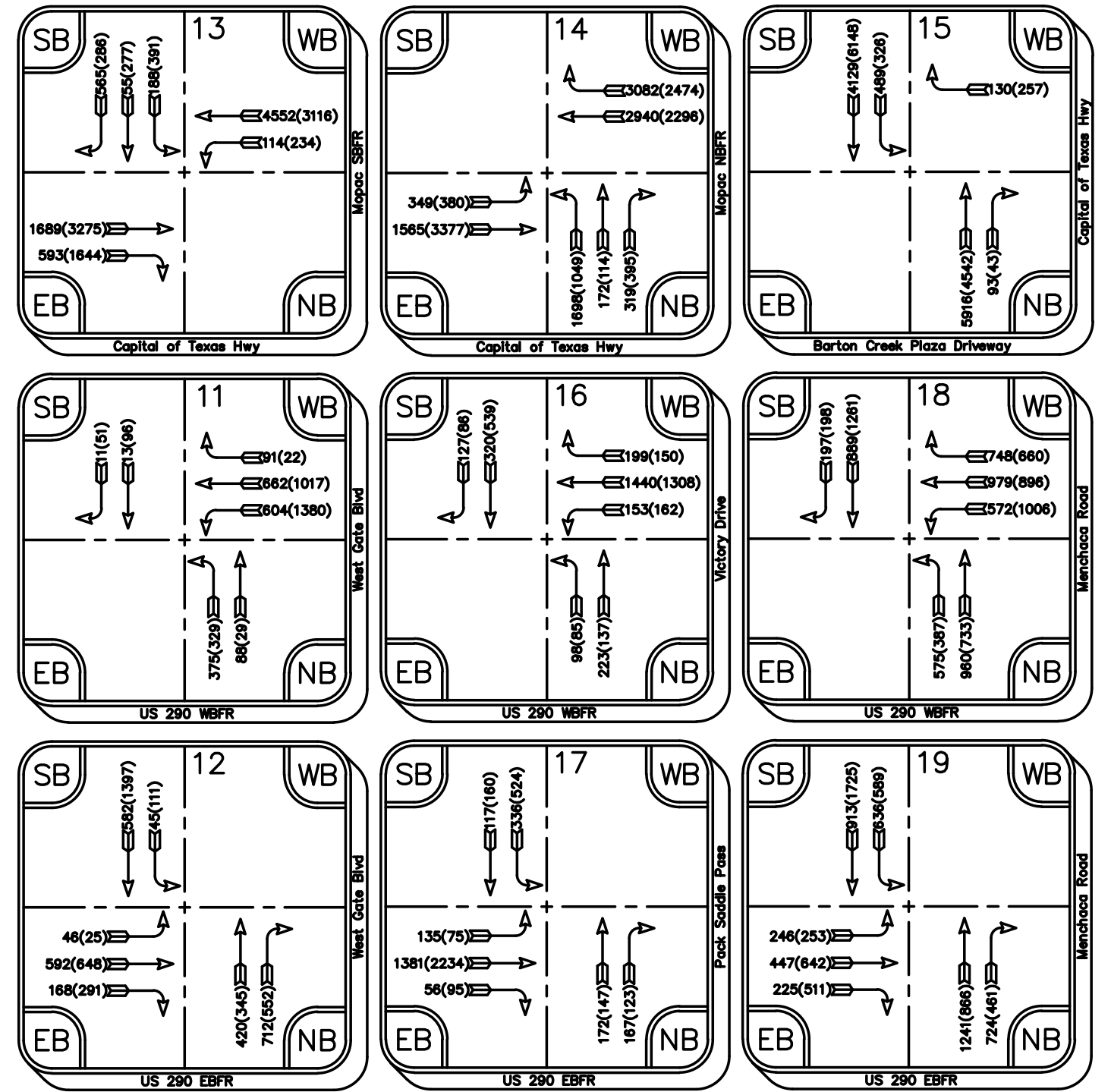
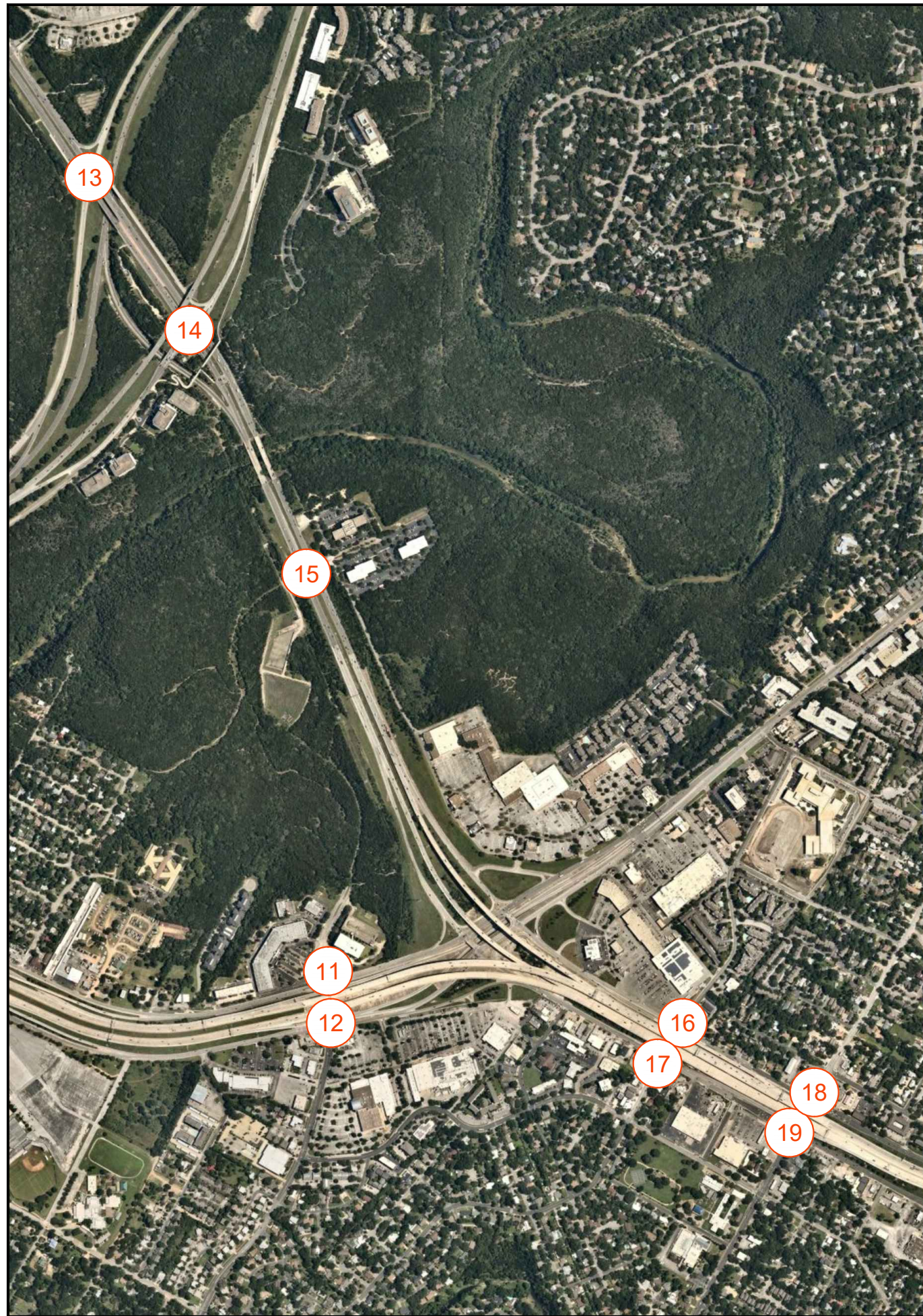

**LEGEND**  
 # STUDY INTERSECTION  
 ##(##) AM(PM) PEAK HOUR VOLUME

FIGURE 6  
 PHASE 2  
 2031 FORECASTED  
 AM & PM PEAK HOUR

**BOE** Consulting Services, LLC  
 9901 Brodie Lane 160-303  
 Austin, Texas 78748  
 Tel. (512) 632-7509  
 TBPE Registration Number F-19220



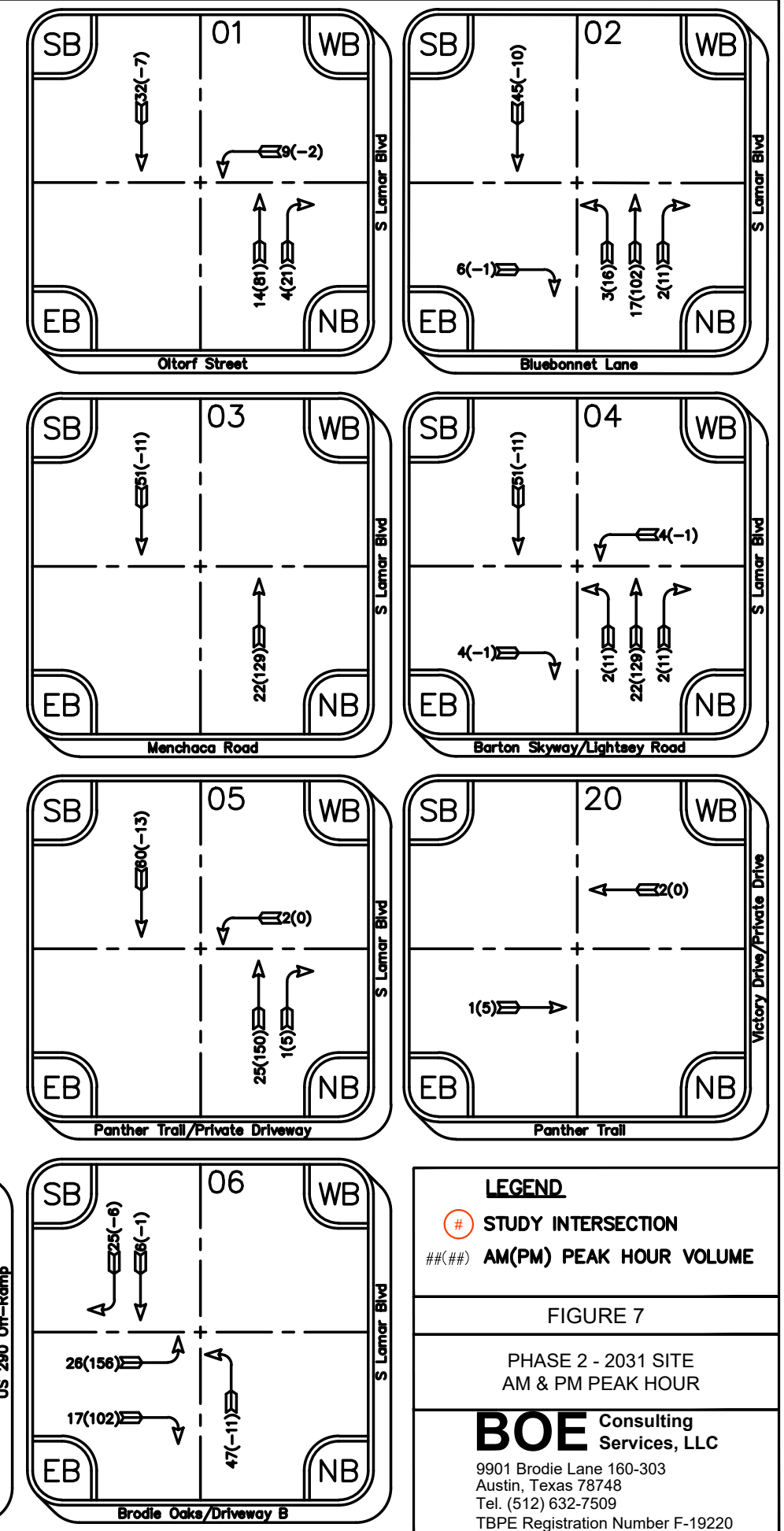
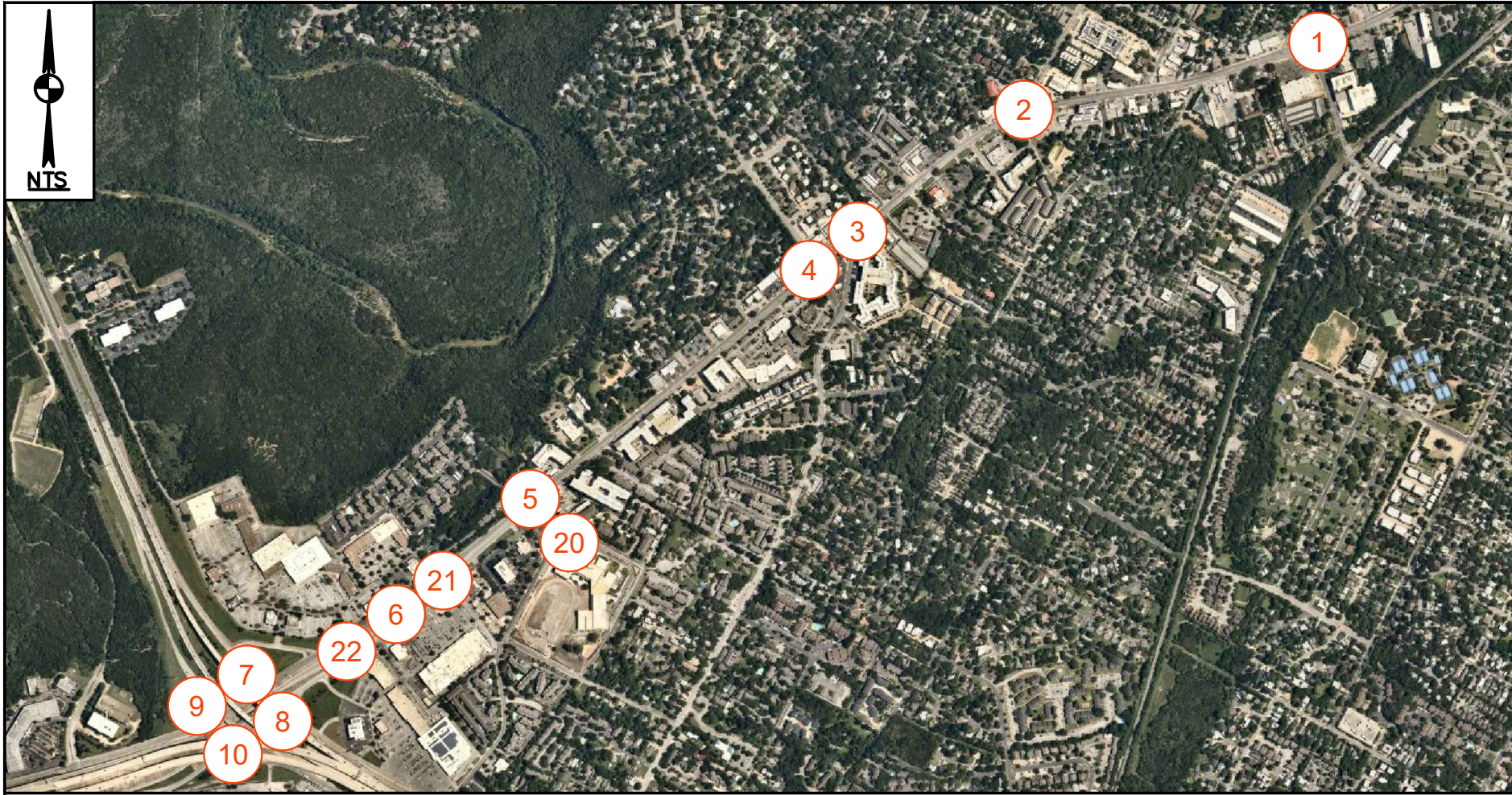

**LEGEND**

- ① STUDY INTERSECTION
- ##(##) AM(PM) PEAK HOUR VOLUME

FIGURE 7

PHASE 2 - 2031 SITE  
AM & PM PEAK HOUR

**BOE** Consulting Services, LLC  
 9901 Brodie Lane 160-303  
 Austin, Texas 78748  
 Tel. (512) 632-7509  
 TBPE Registration Number F-19220



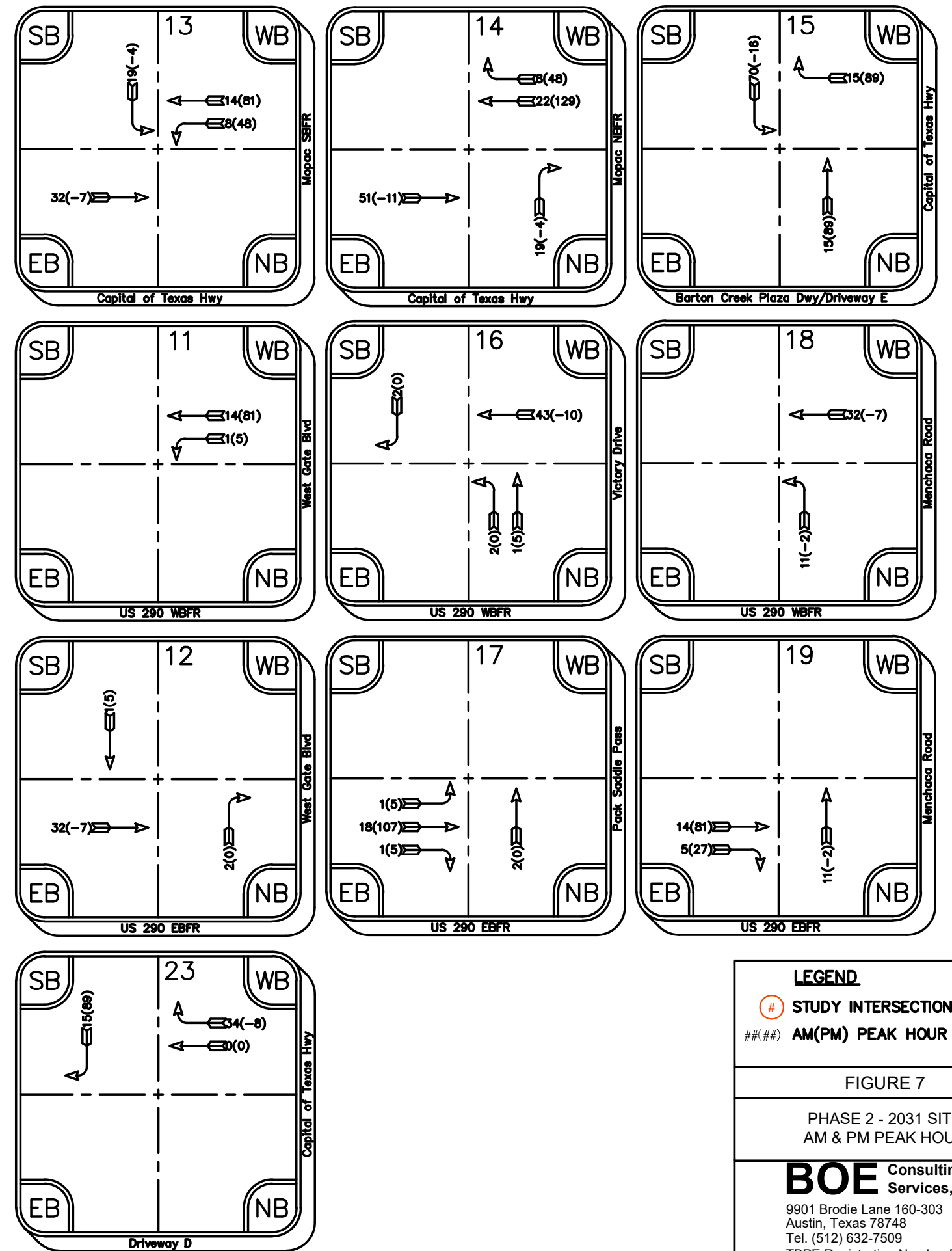
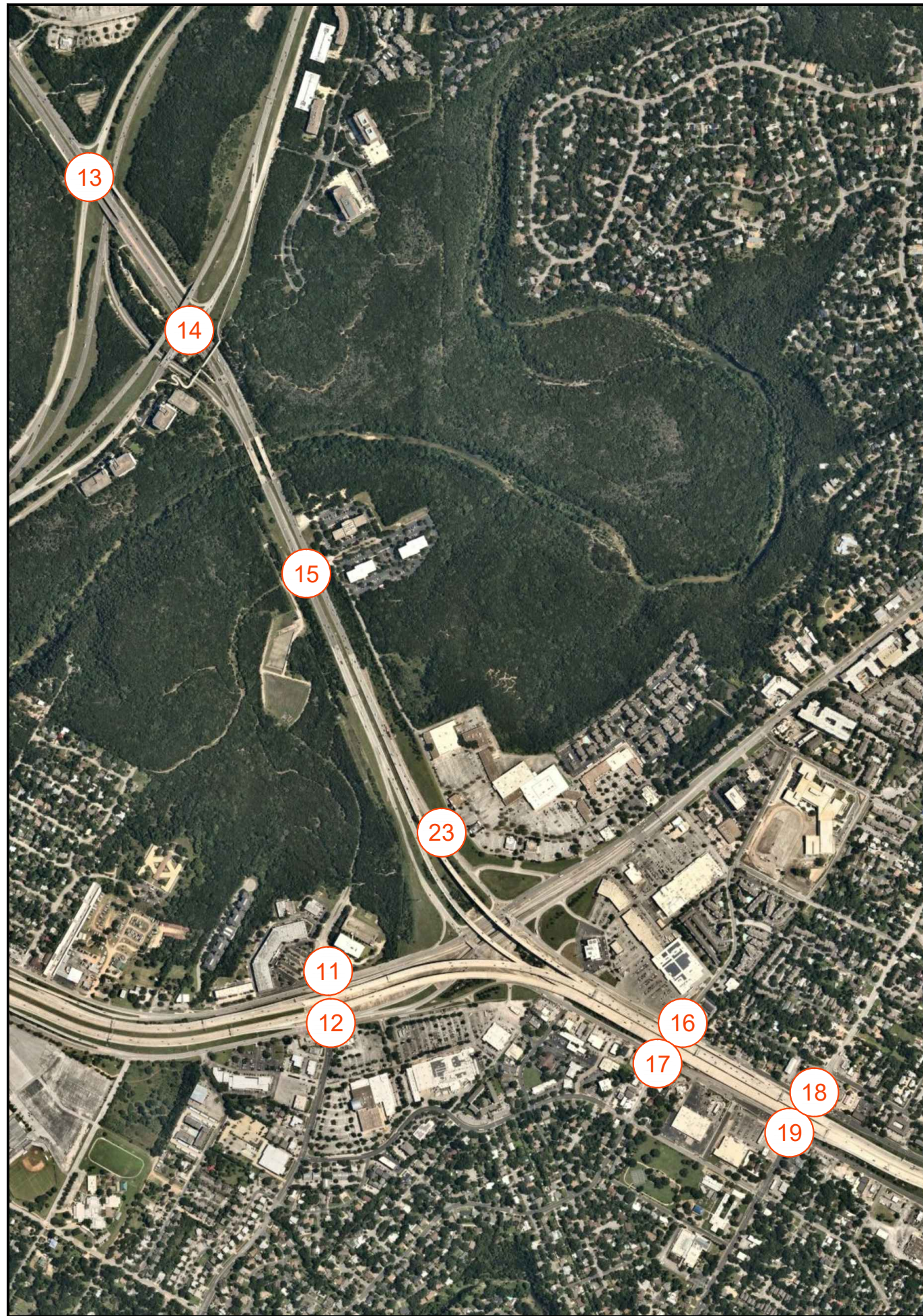



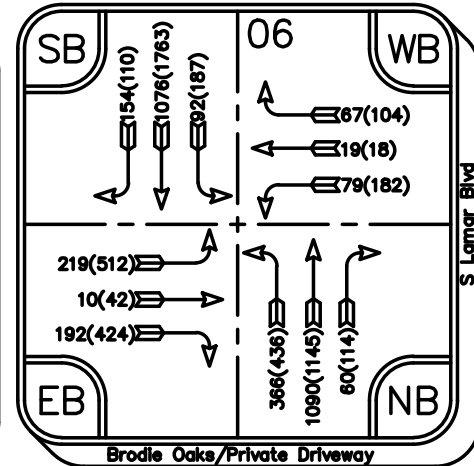
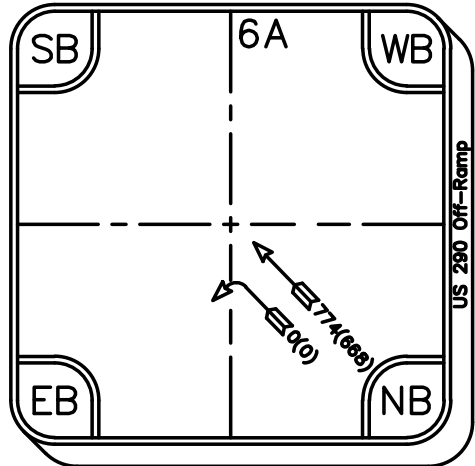
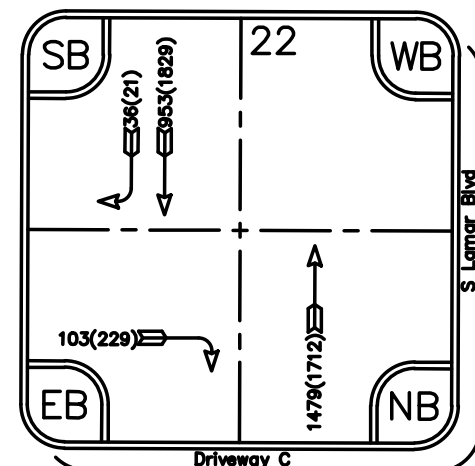
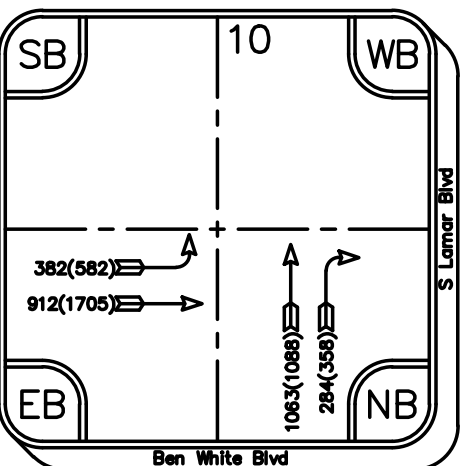
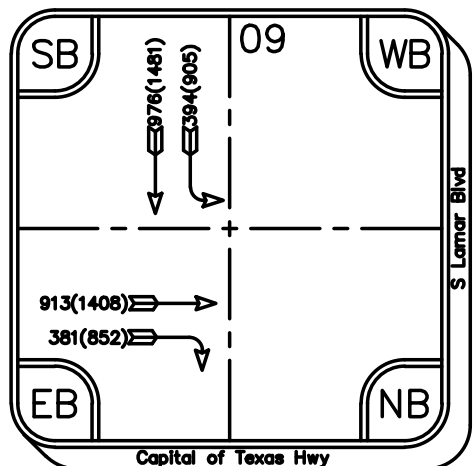
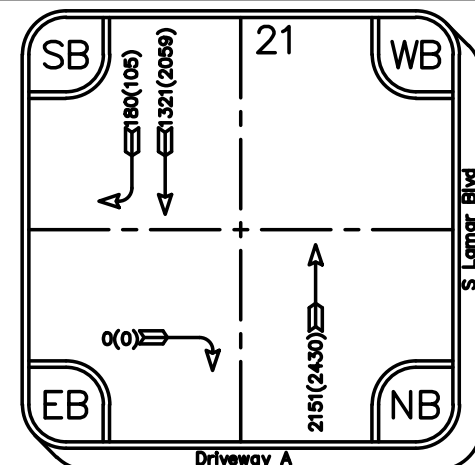
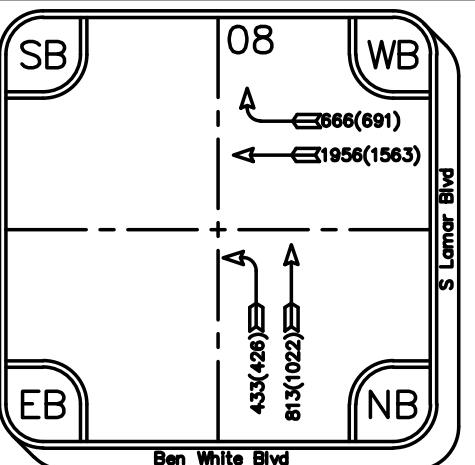
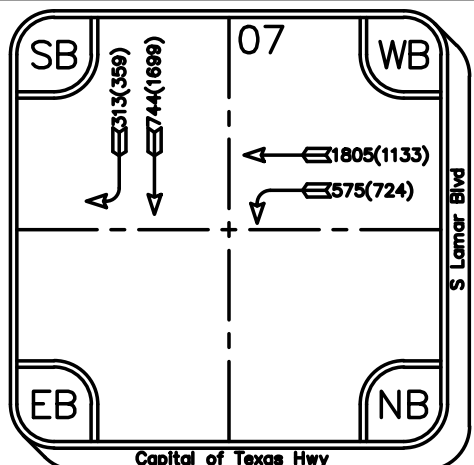
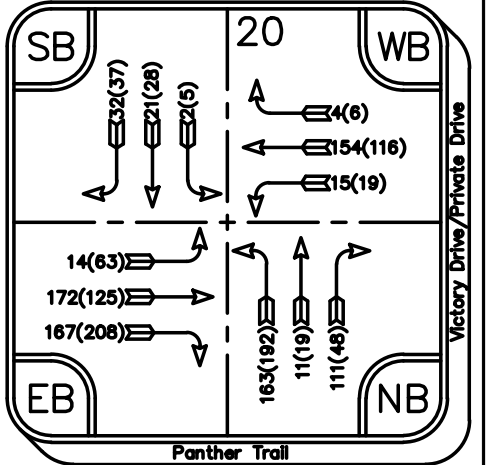
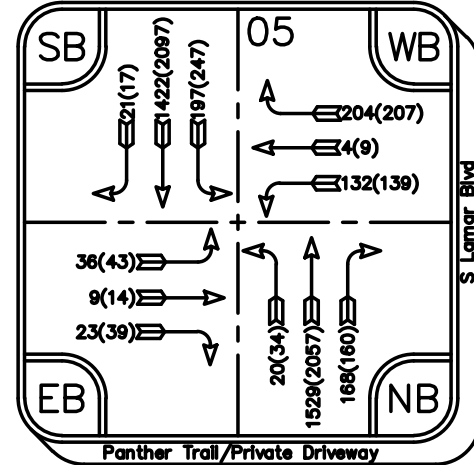
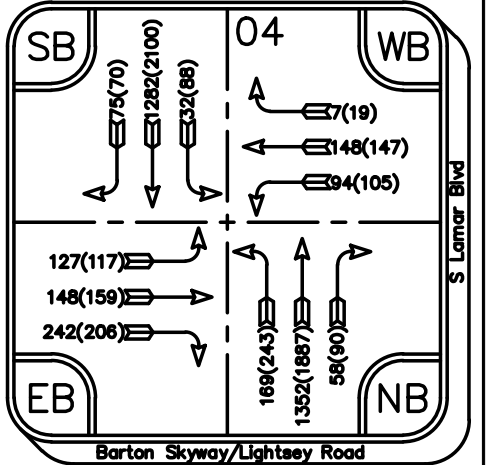
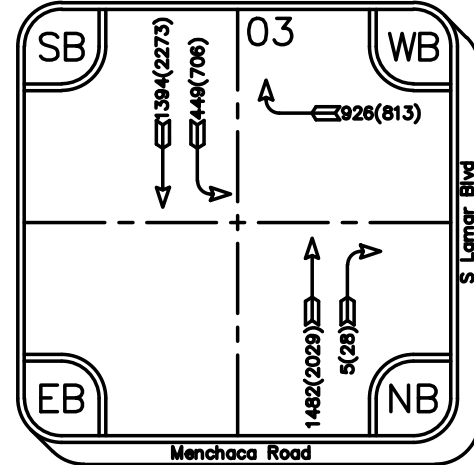
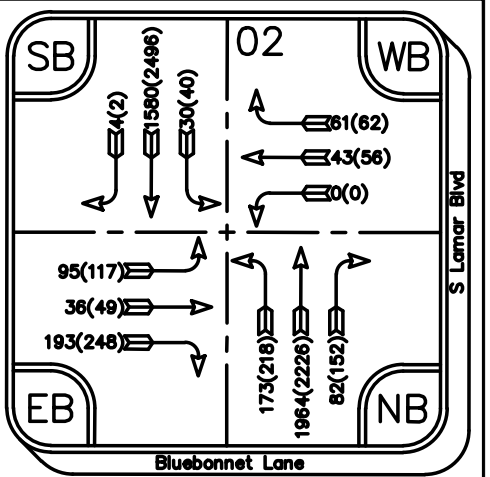
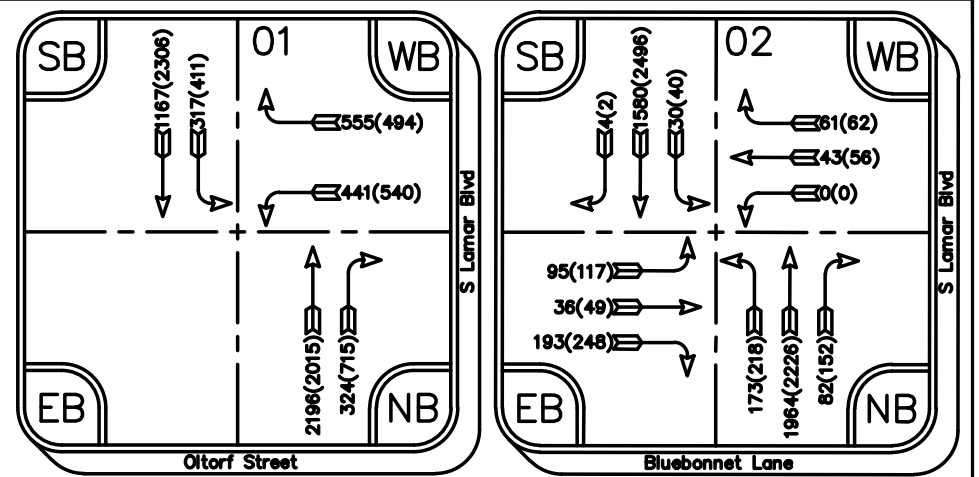
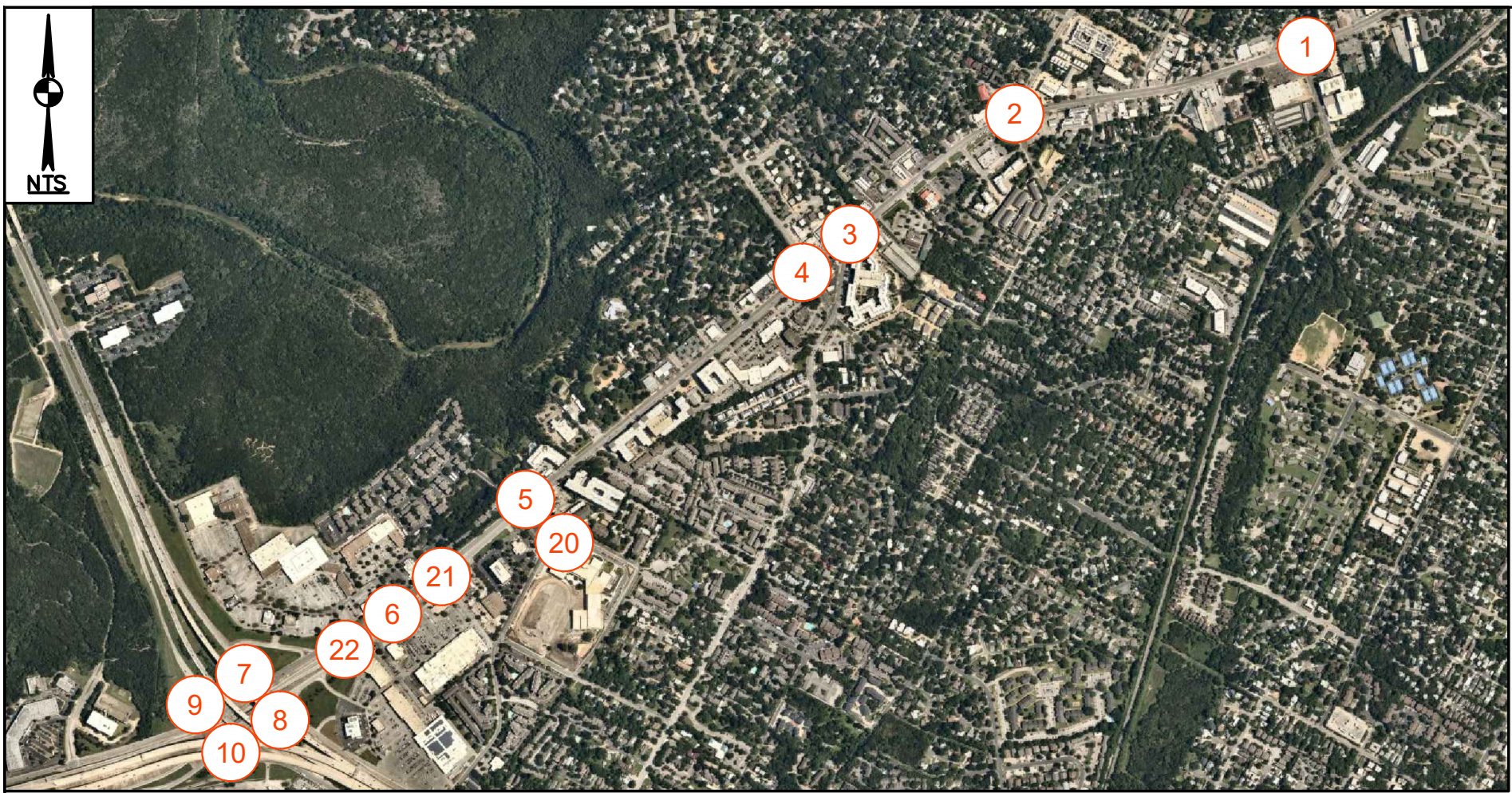

**LEGEND**

- ⊙ STUDY INTERSECTION
- ##(##) AM(PM) PEAK HOUR VOLUME

FIGURE 8

PHASE 2  
2031 SITE+FORECASTED  
AM & PM PEAK HOUR

**BOE** Consulting Services, LLC

9901 Brodie Lane 160-303  
Austin, Texas 78748  
Tel. (512) 632-7509  
TBPE Registration Number F-19220



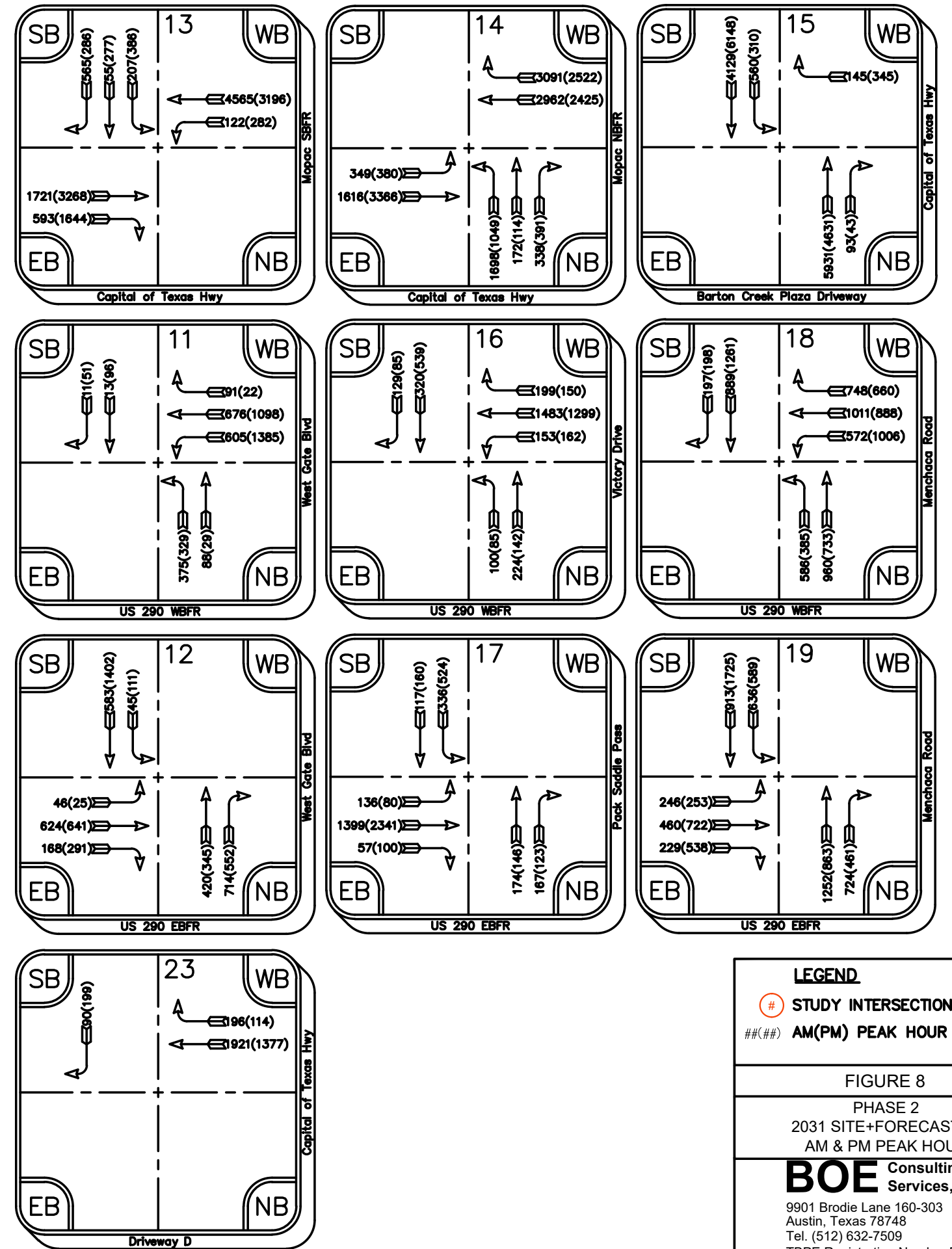
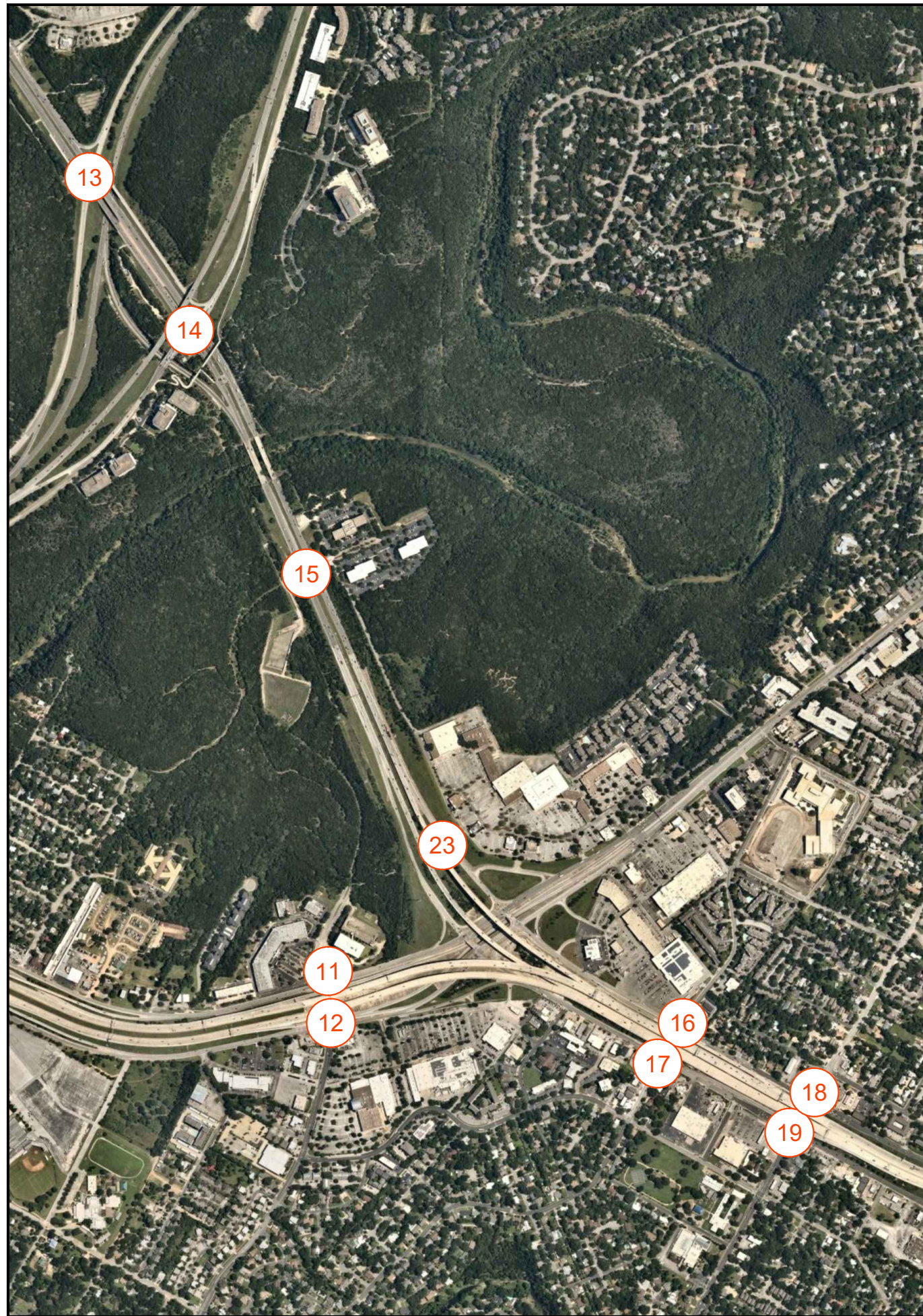

**LEGEND**

- ⊙ STUDY INTERSECTION
- ##(##) AM(PM) PEAK HOUR VOLUME

**FIGURE 8**

PHASE 2  
2031 SITE+FORECASTED  
AM & PM PEAK HOUR

**BOE** Consulting Services, LLC  
9901 Brodie Lane 160-303  
Austin, Texas 78748  
Tel. (512) 632-7509  
TBPE Registration Number F-19220



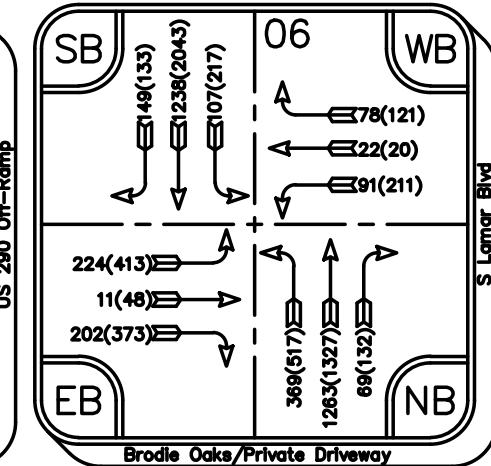
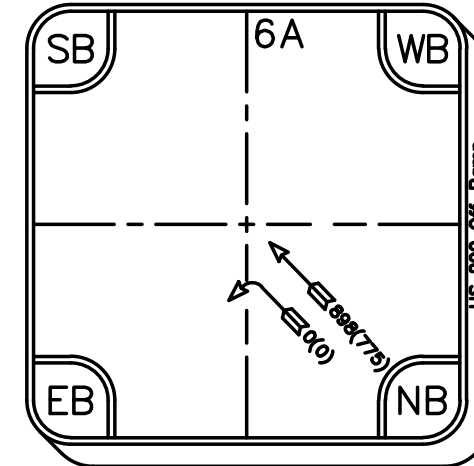
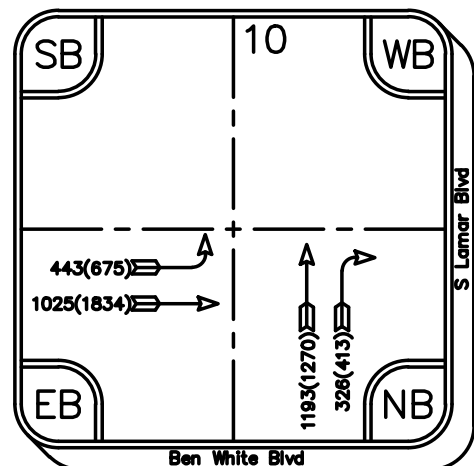
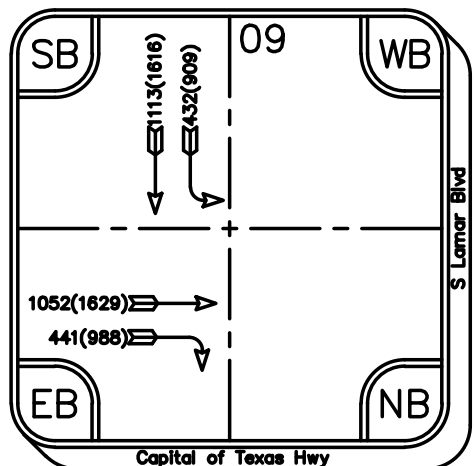
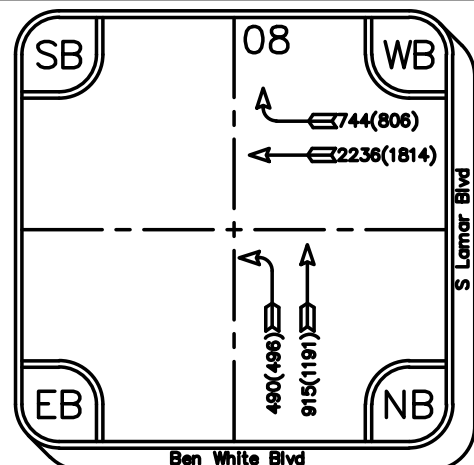
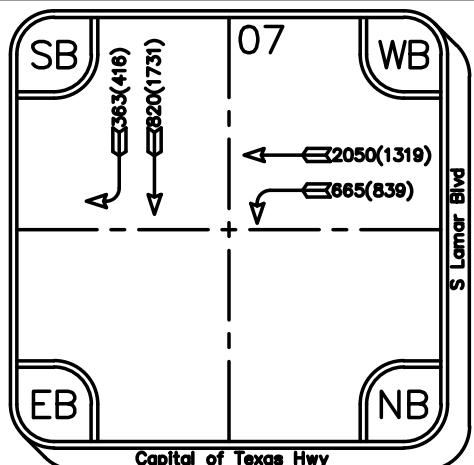
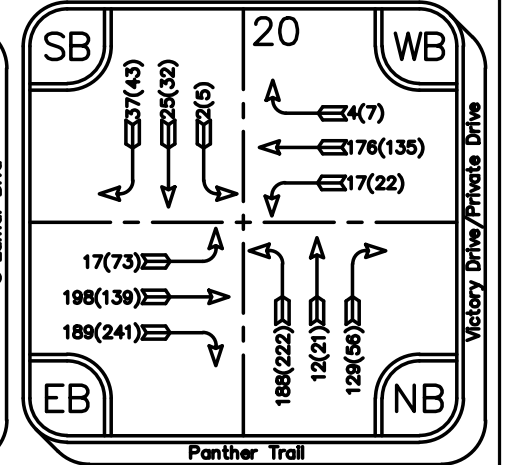
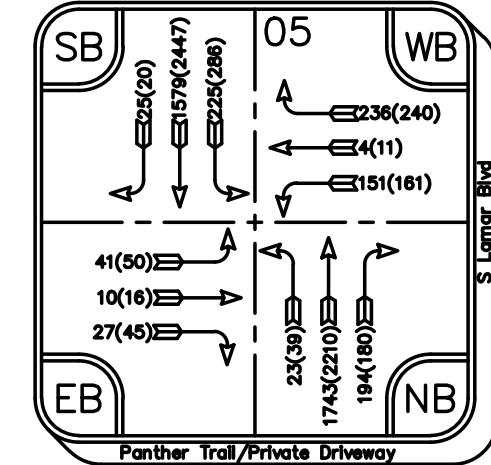
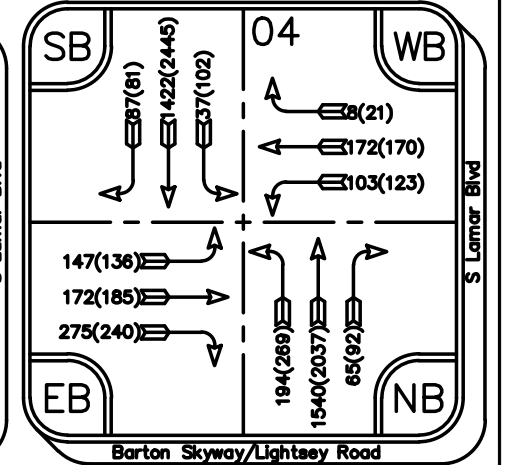
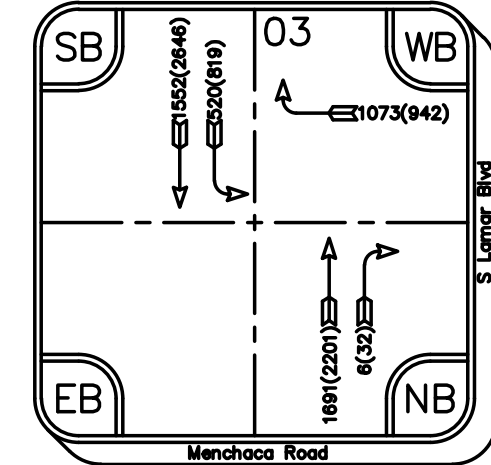
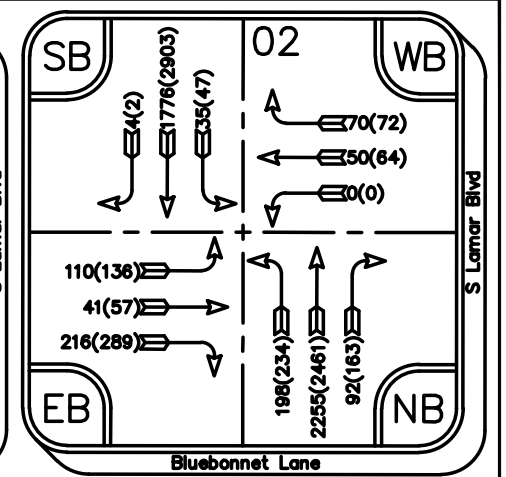
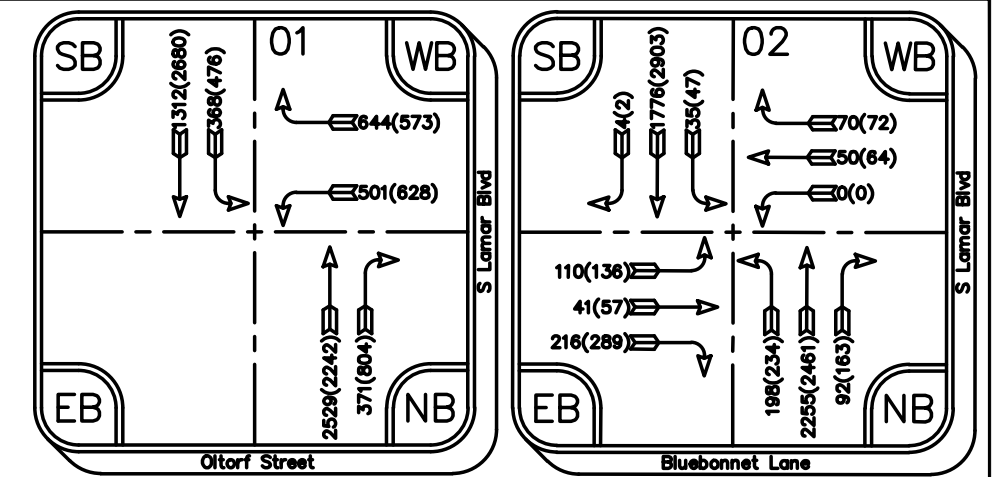
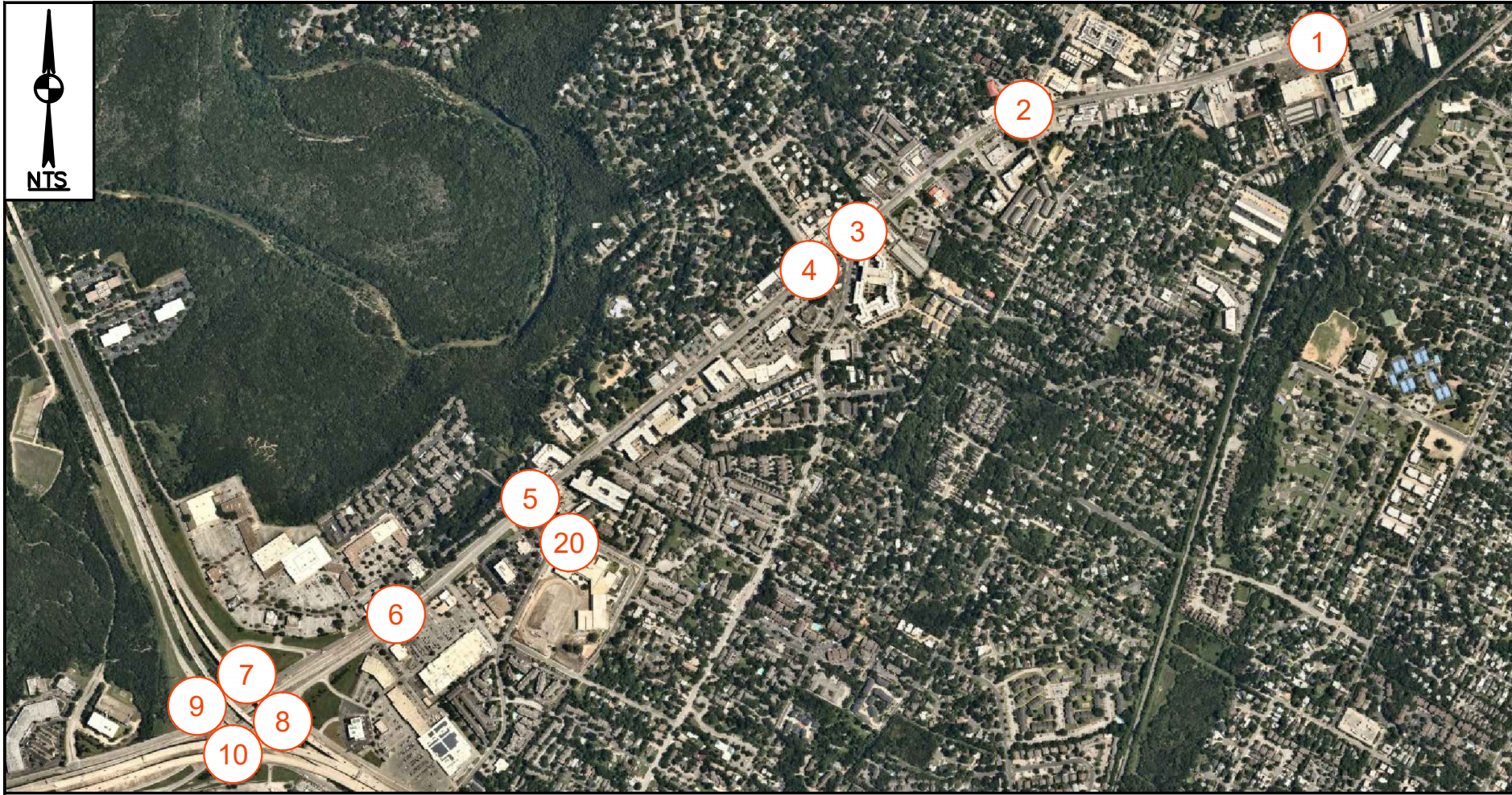

**LEGEND**  
 # STUDY INTERSECTION  
 ##(##) AM(PM) PEAK HOUR VOLUME

FIGURE 9  
 PHASE 3  
 2036 FORECASTED  
 AM & PM PEAK HOUR

**BOE** Consulting Services, LLC  
 9901 Brodie Lane 160-303  
 Austin, Texas 78748  
 Tel. (512) 632-7509  
 TBPE Registration Number F-19220



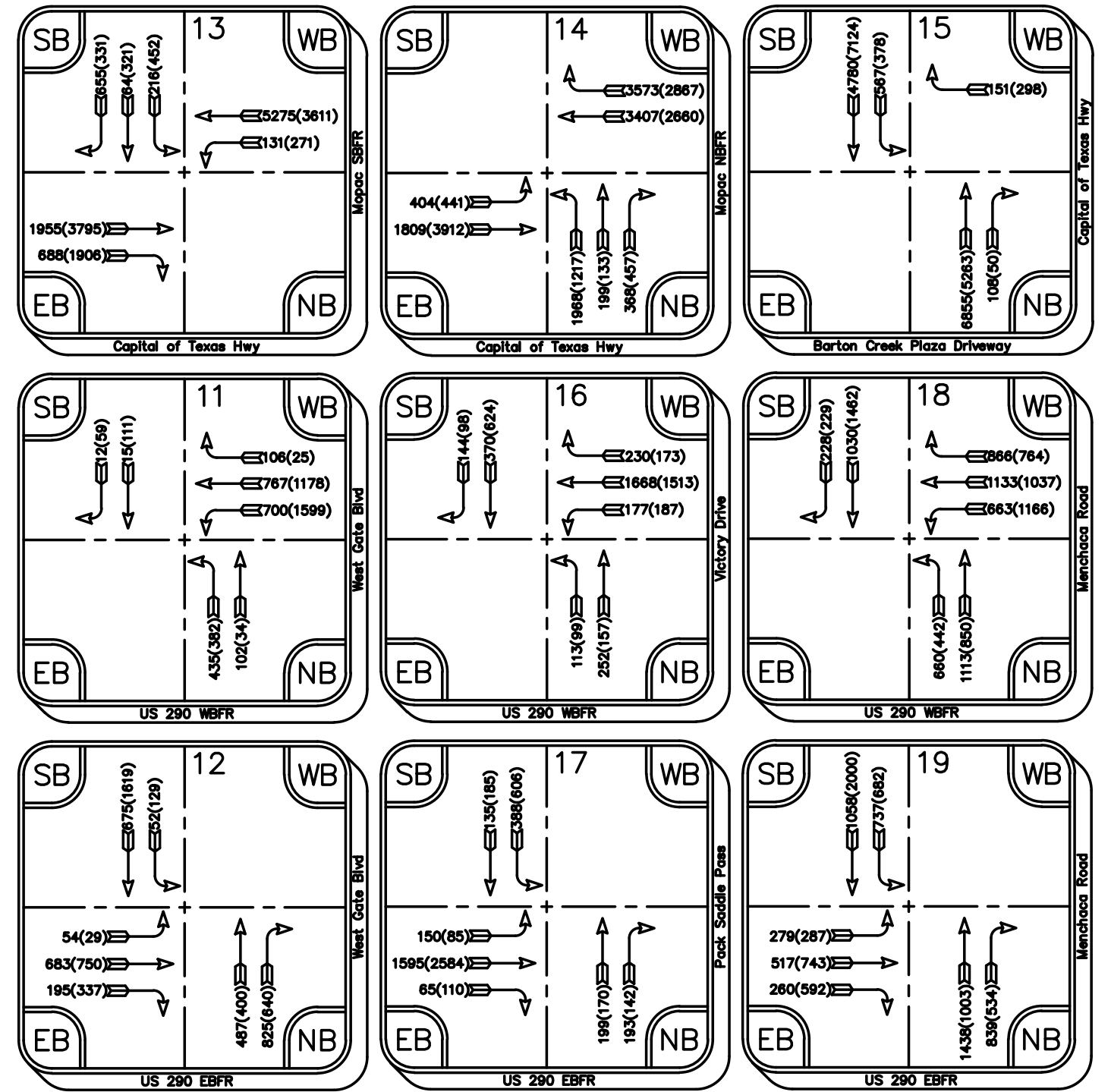
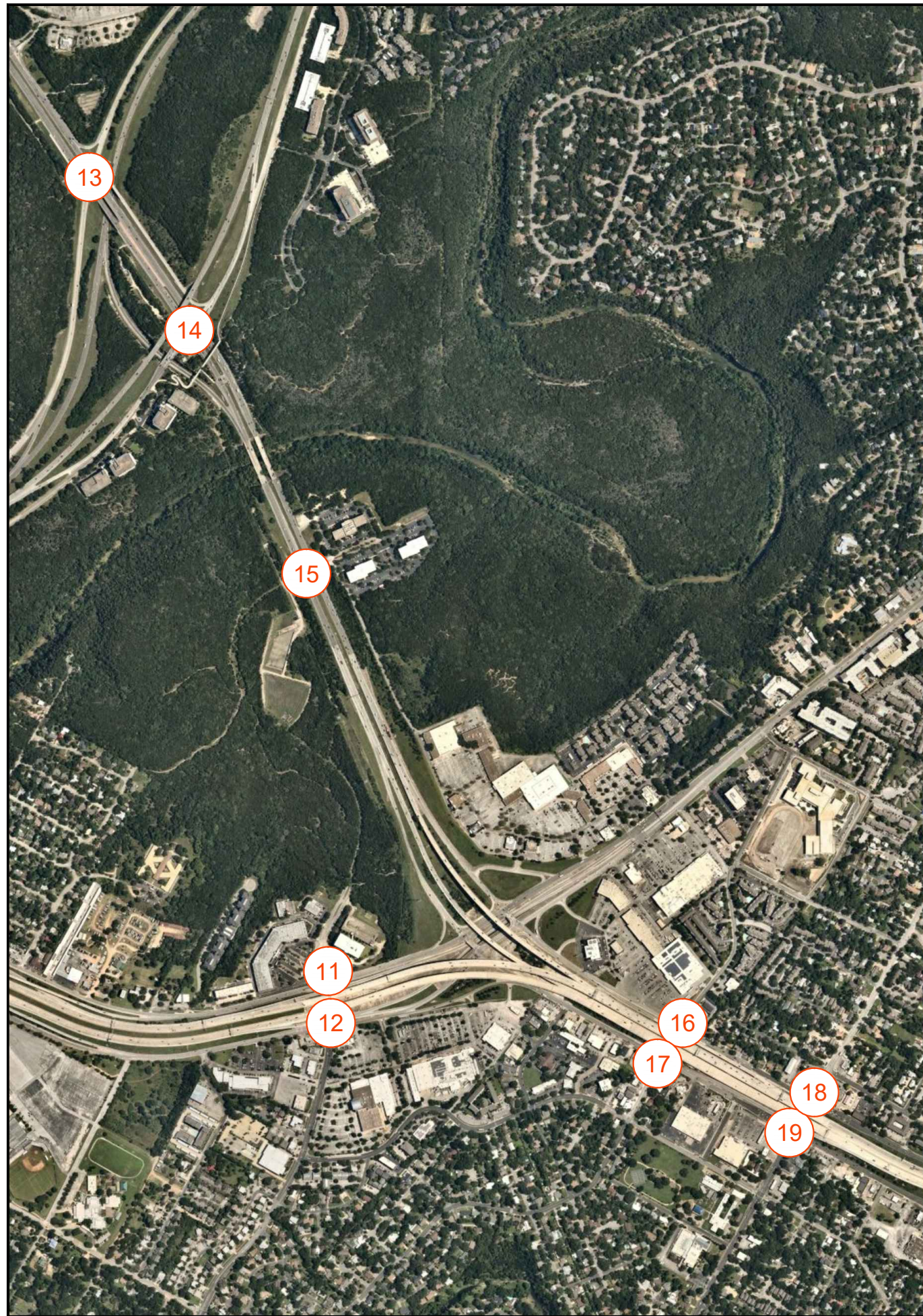

**LEGEND**

# STUDY INTERSECTION  
 ##(##) AM(PM) PEAK HOUR VOLUME

FIGURE 9  
 PHASE 3  
 2036 FORECASTED  
 AM & PM PEAK HOUR

**BOE** Consulting Services, LLC  
 9901 Brodie Lane 160-303  
 Austin, Texas 78748  
 Tel. (512) 632-7509  
 TBPE Registration Number F-19220



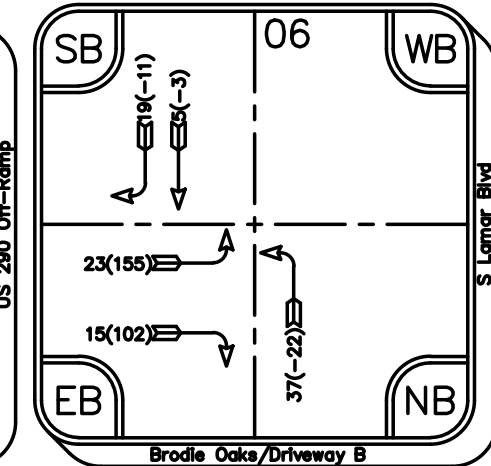
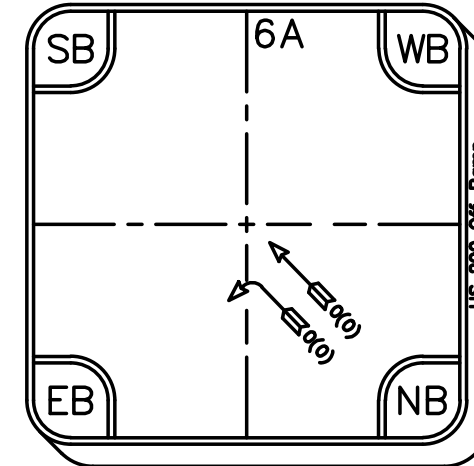
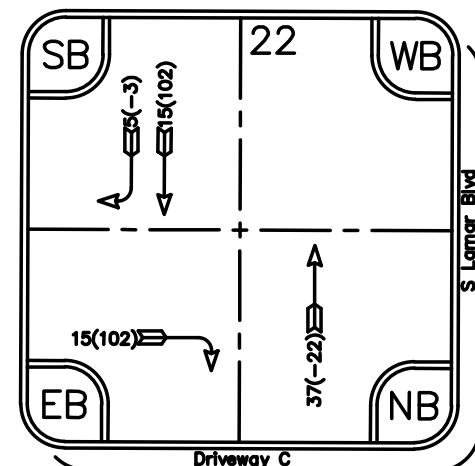
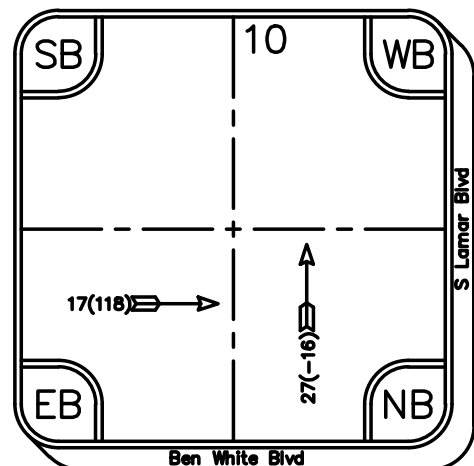
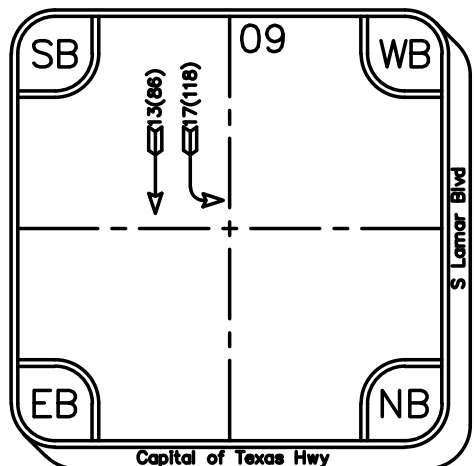
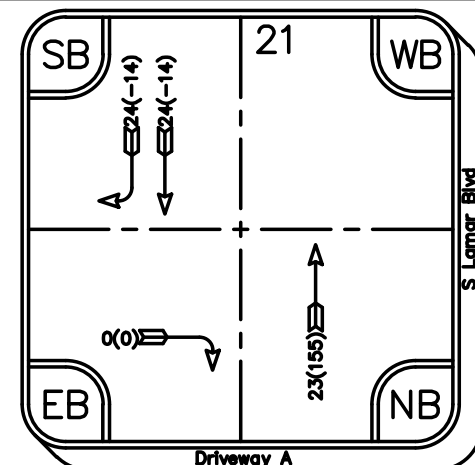
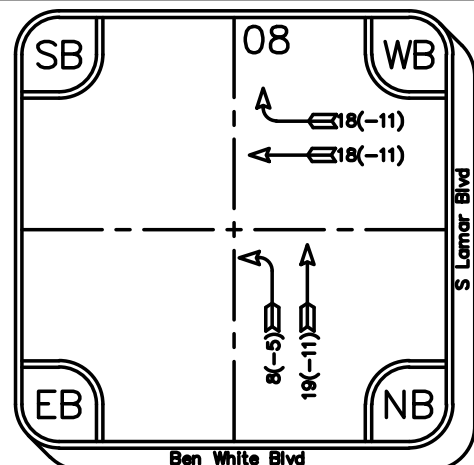
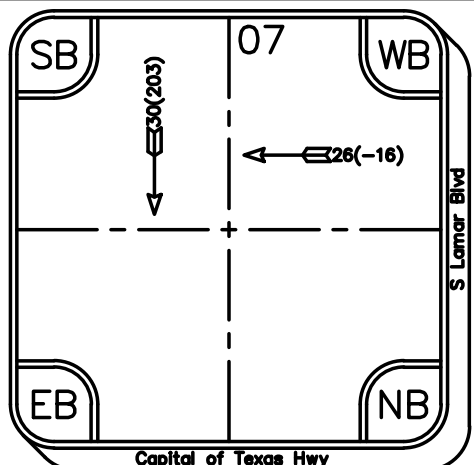
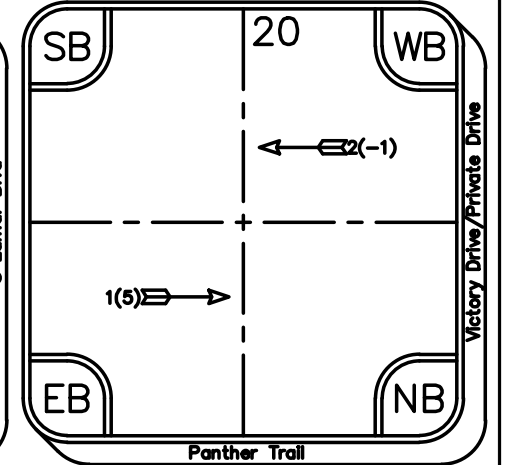
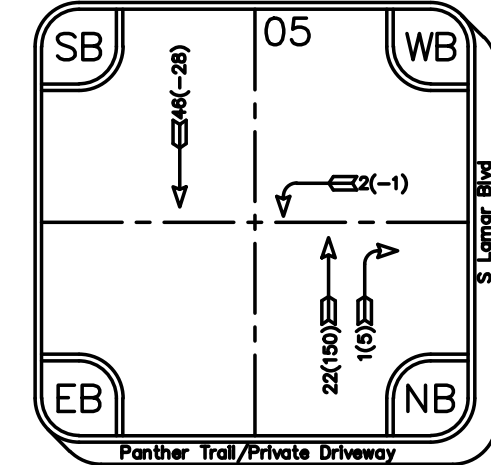
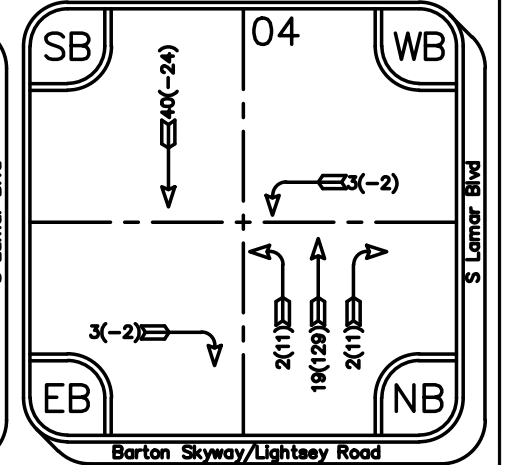
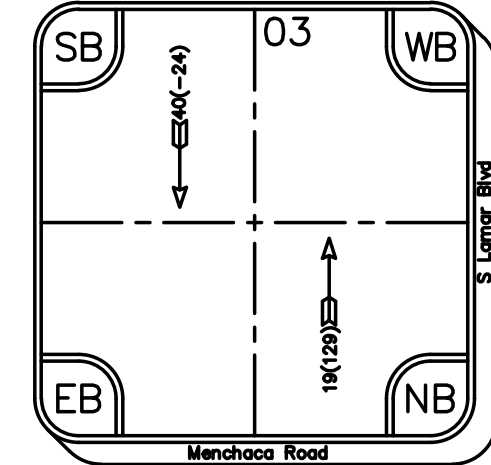
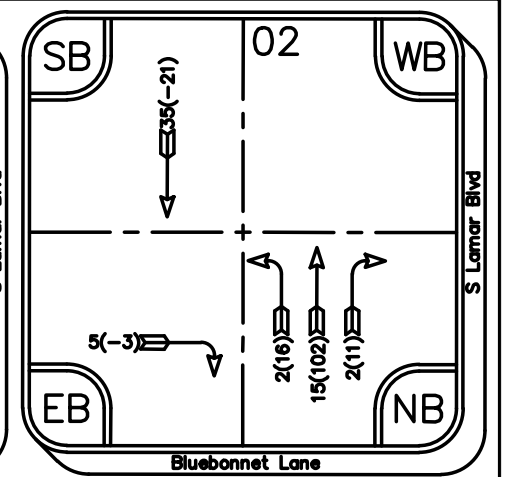
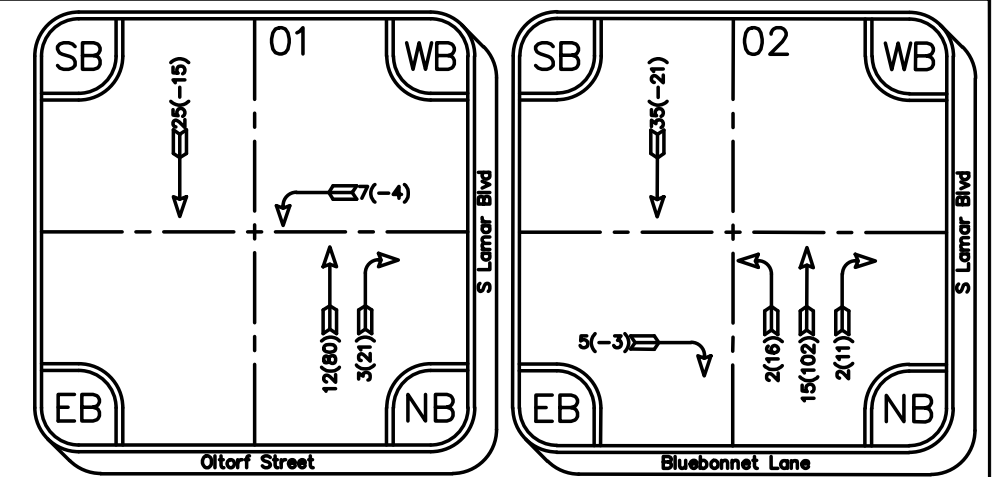
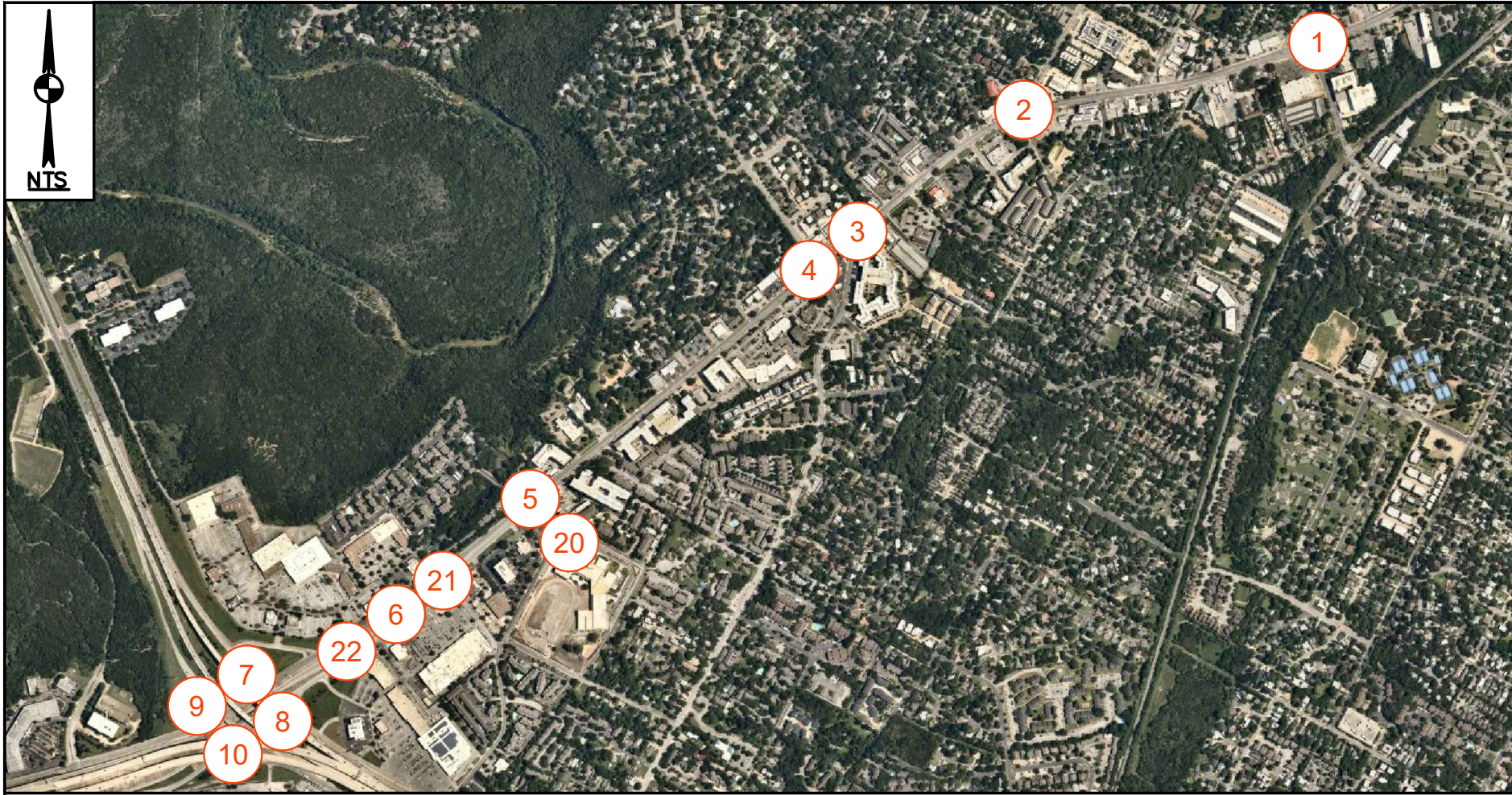

**LEGEND**  
 # STUDY INTERSECTION  
 ##(##) AM(PM) PEAK HOUR VOLUME

FIGURE 10  
 PHASE 3 - 2036 SITE  
 AM & PM PEAK HOUR

**BOE** Consulting Services, LLC  
 9901 Brodie Lane 160-303  
 Austin, Texas 78748  
 Tel. (512) 632-7509  
 TBPE Registration Number F-19220



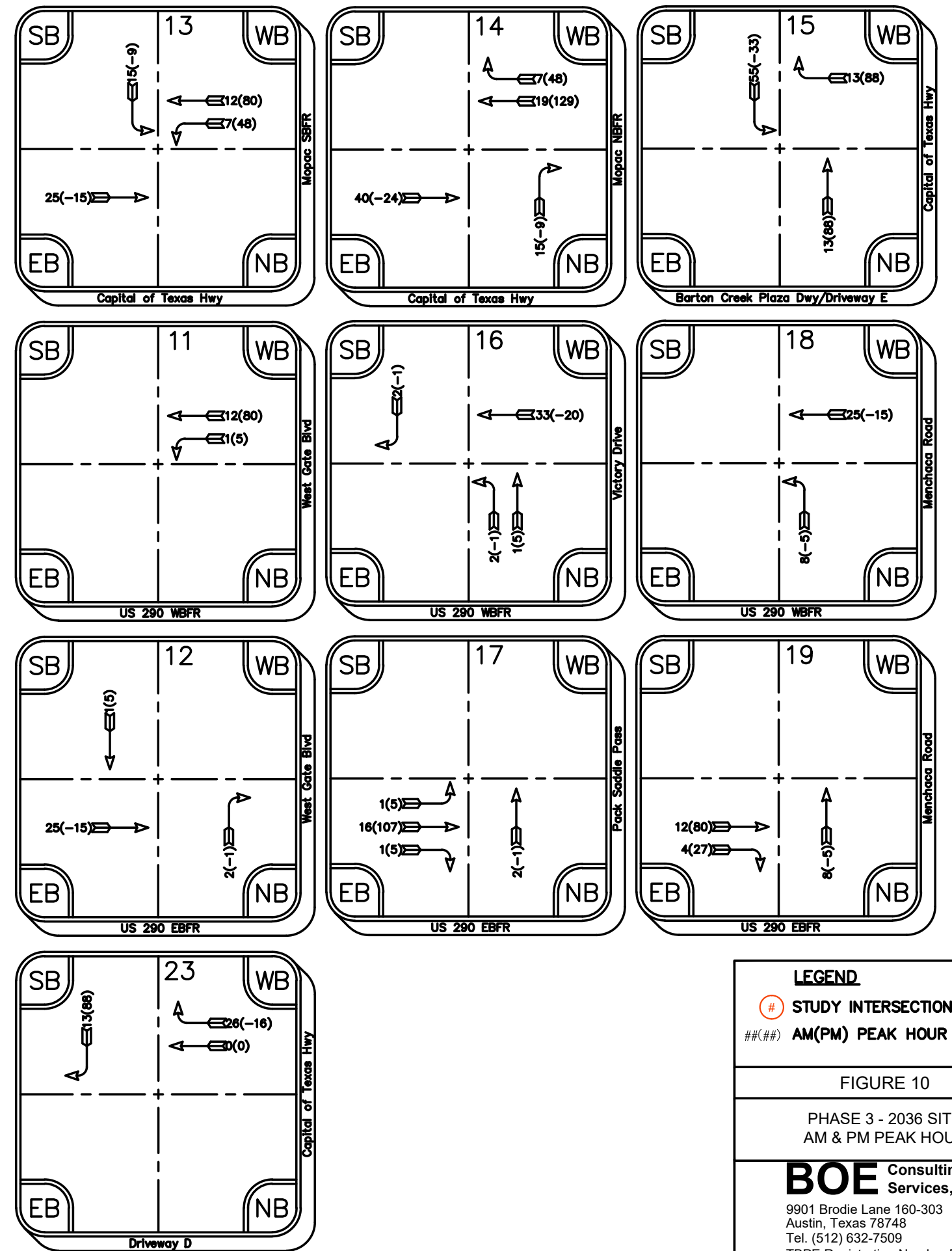
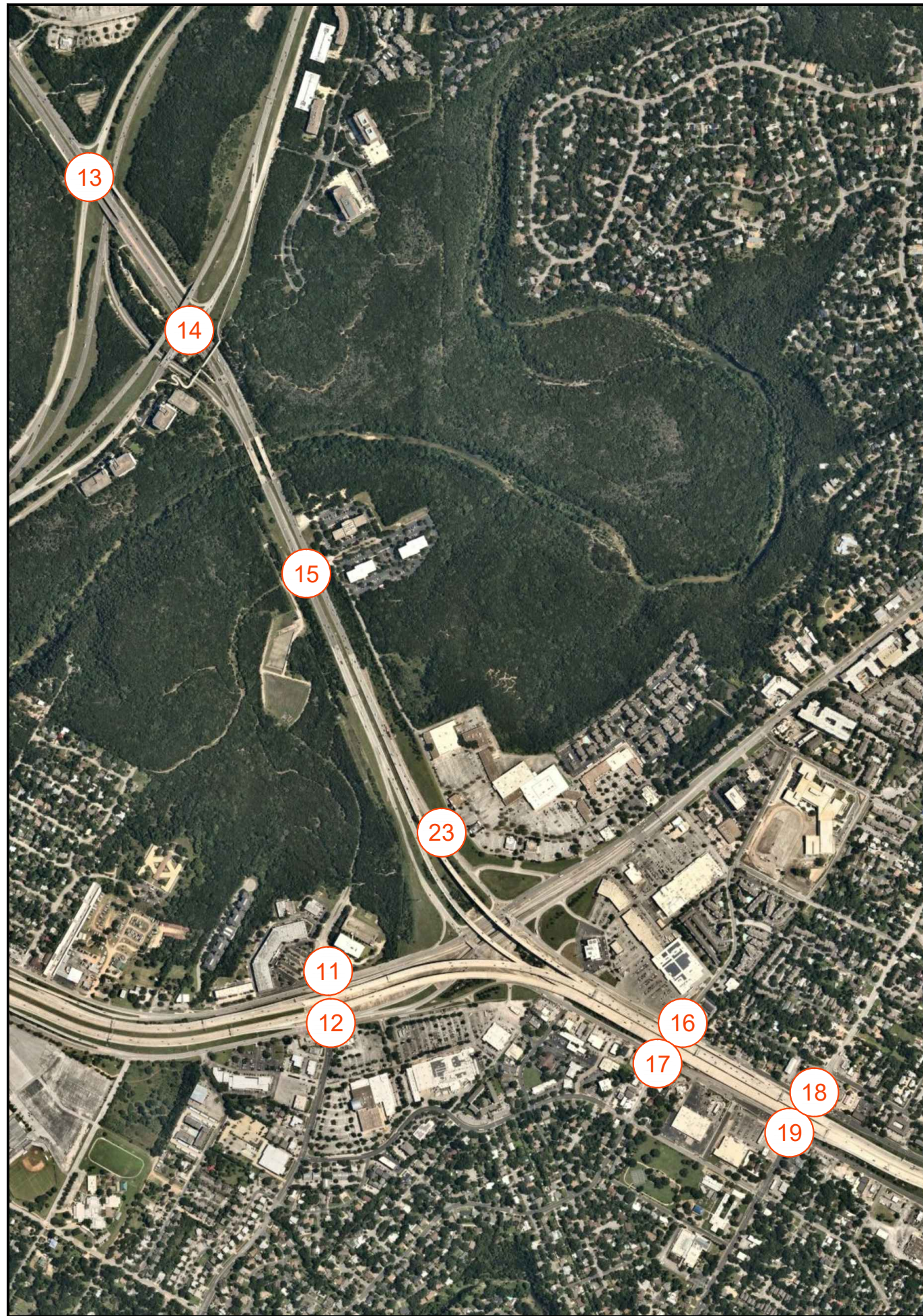

**LEGEND**

⊙ STUDY INTERSECTION

##(##) AM(PM) PEAK HOUR VOLUME

---

FIGURE 10

PHASE 3 - 2036 SITE  
AM & PM PEAK HOUR

**BOE** Consulting Services, LLC  
 9901 Brodie Lane 160-303  
 Austin, Texas 78748  
 Tel. (512) 632-7509  
 TBPE Registration Number F-19220



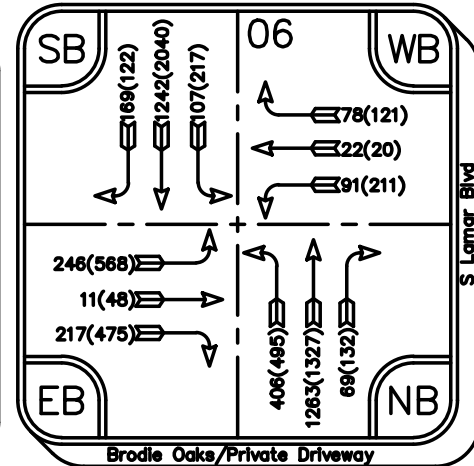
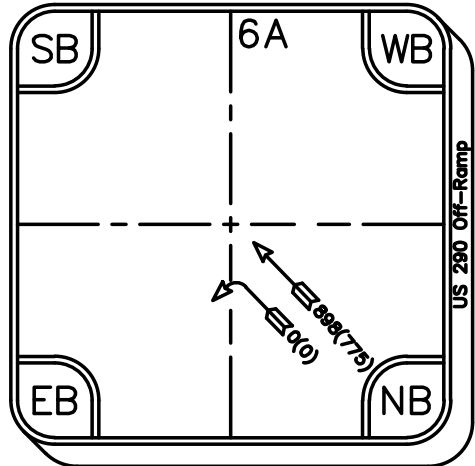
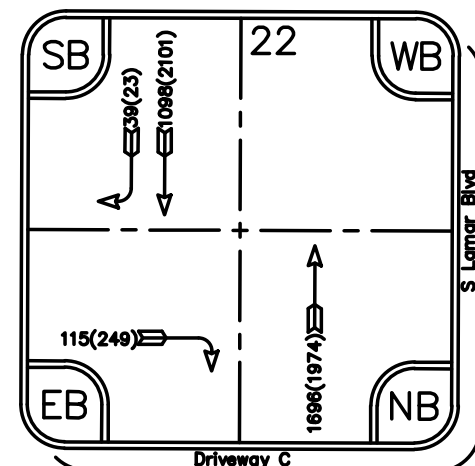
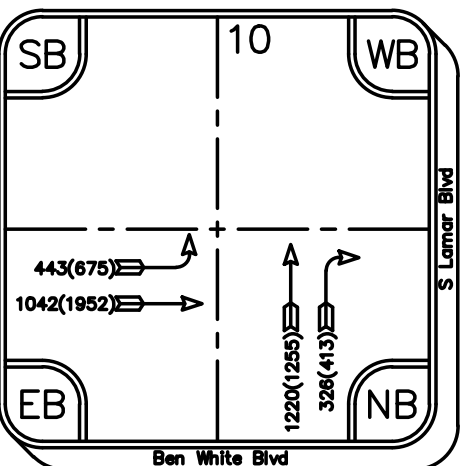
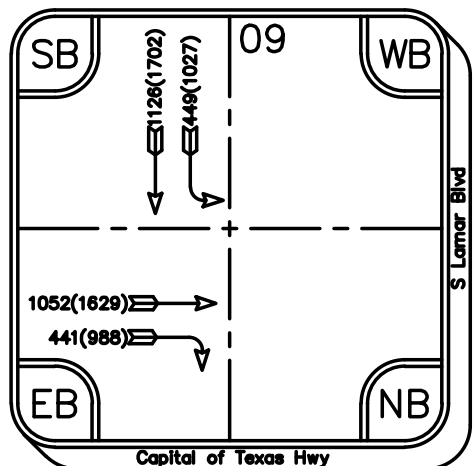
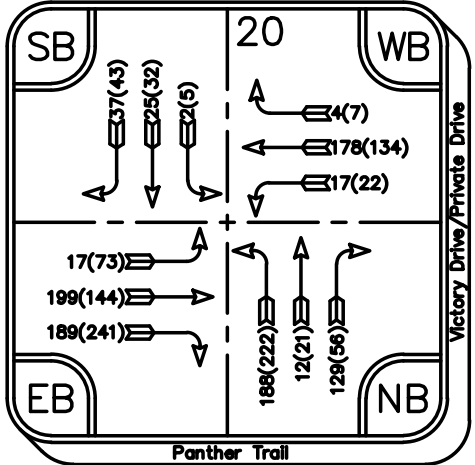
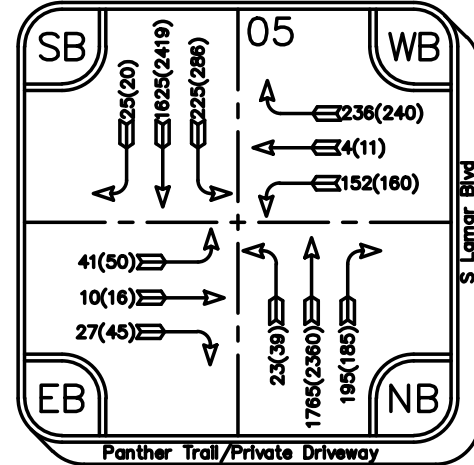
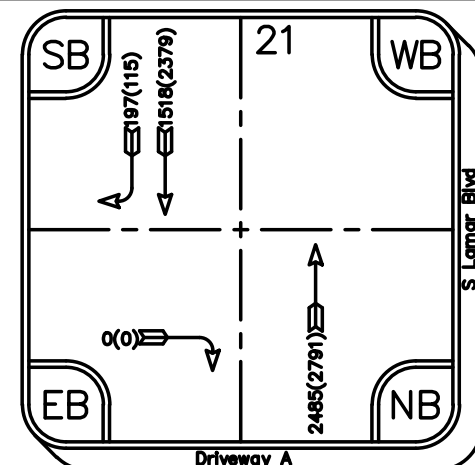
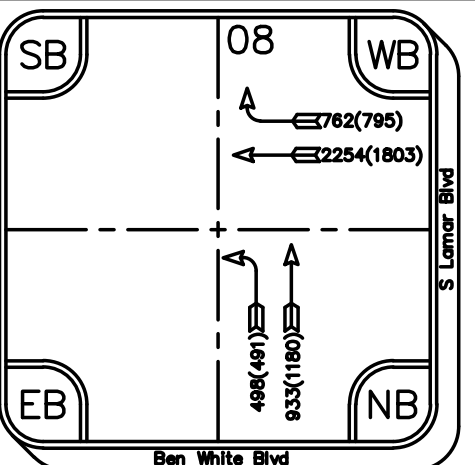
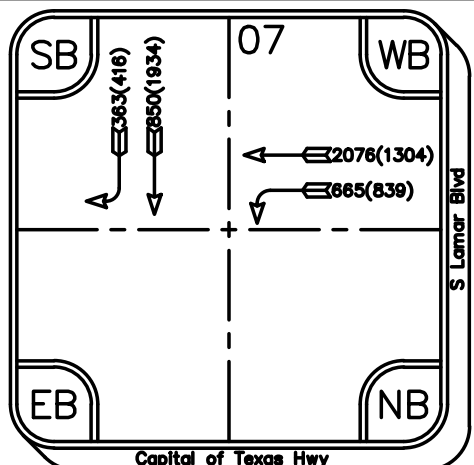
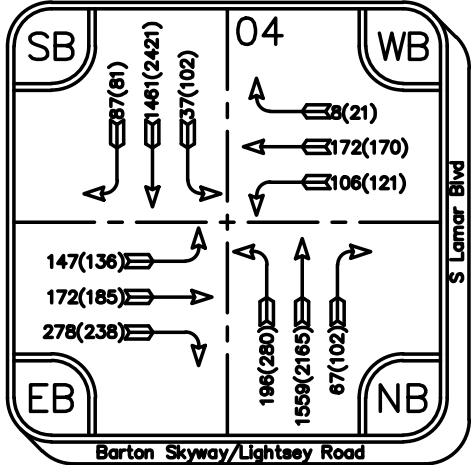
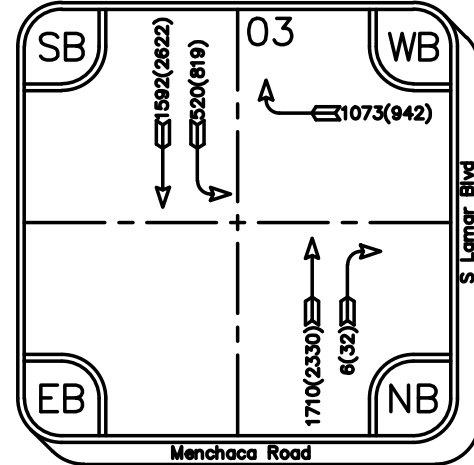
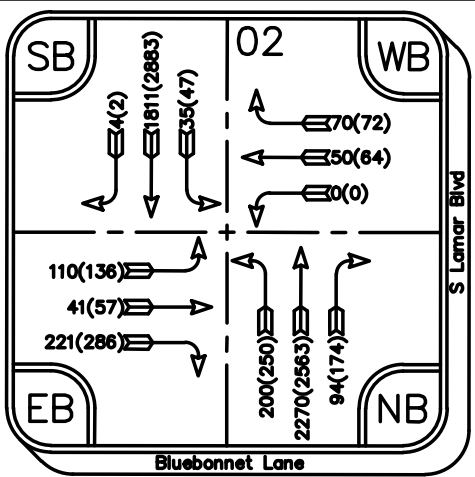
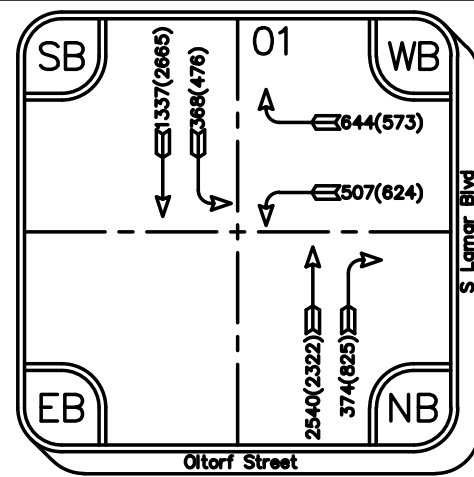
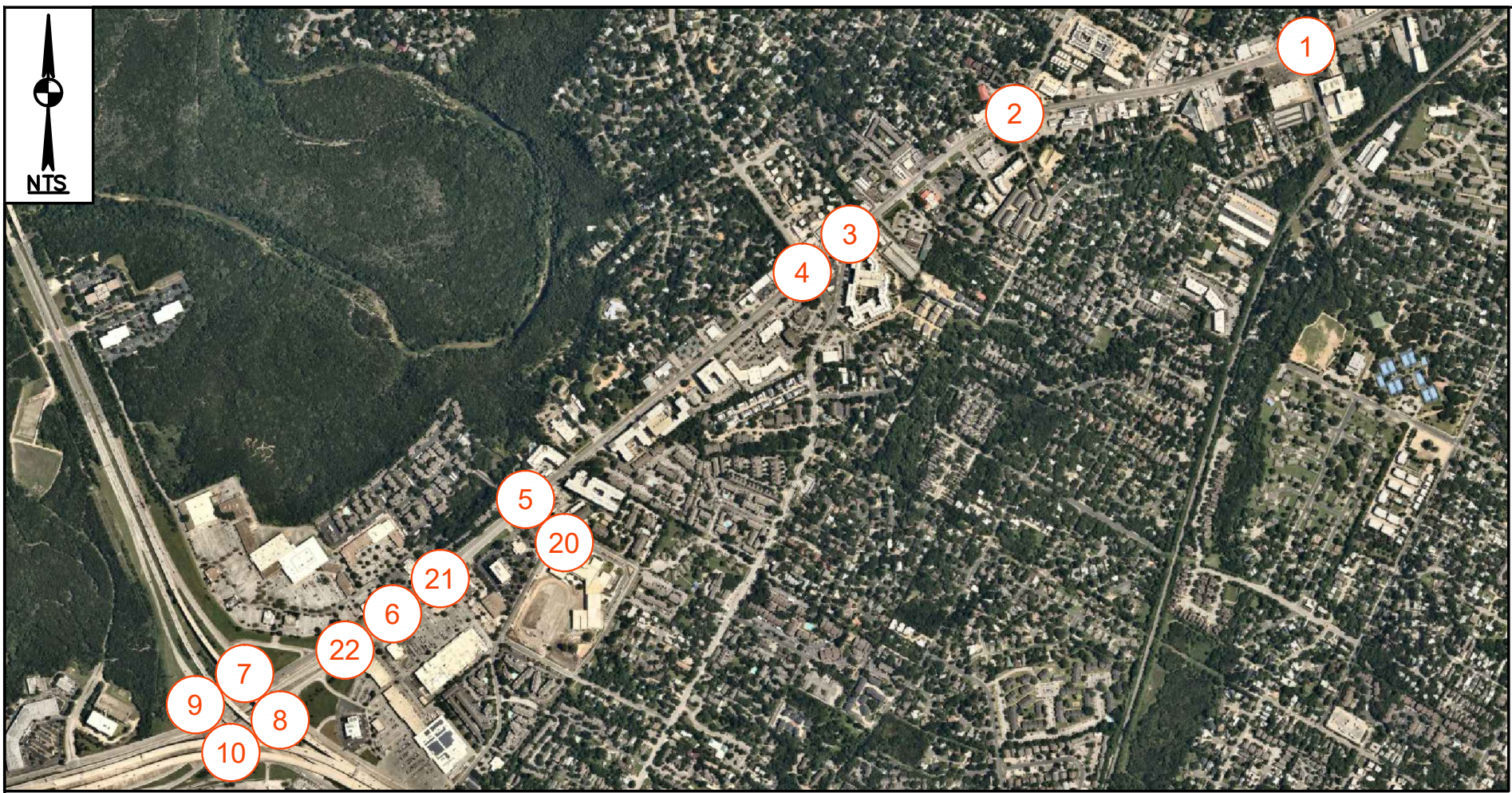

**LEGEND**  
 # STUDY INTERSECTION  
 ##(##) AM(PM) PEAK HOUR VOLUME

FIGURE 11  
 PHASE 3  
 2036 SITE+FORECASTED  
 AM & PM PEAK HOUR  
**BOE** Consulting Services, LLC  
 9901 Brodie Lane 160-303  
 Austin, Texas 78748  
 Tel. (512) 632-7509  
 TBPE Registration Number F-19220



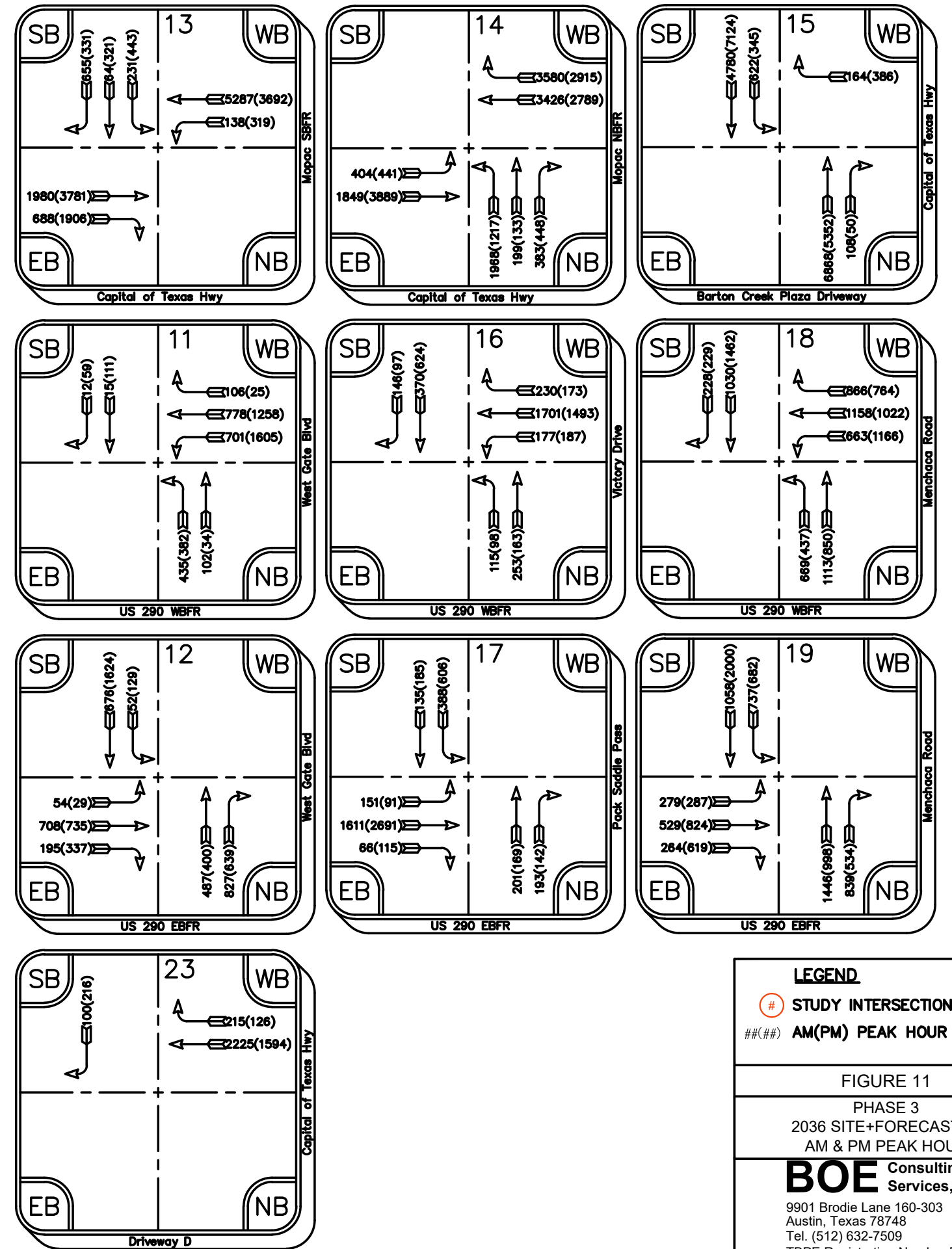
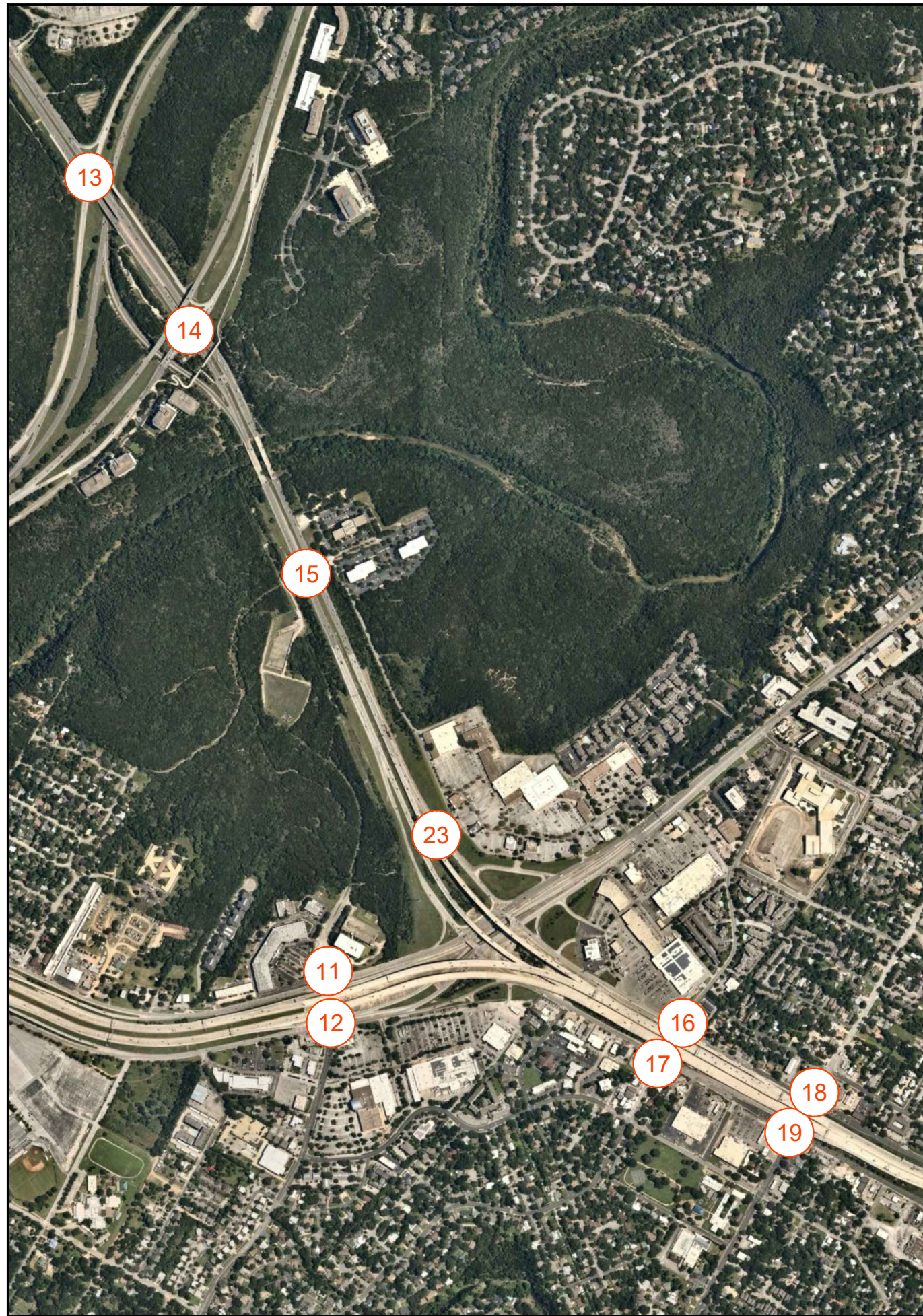

**LEGEND**

- ⊙ STUDY INTERSECTION
- ##(##) AM(PM) PEAK HOUR VOLUME

**FIGURE 11**

PHASE 3  
2036 SITE+FORECASTED  
AM & PM PEAK HOUR

**BOE** Consulting Services, LLC  
9901 Brodie Lane 160-303  
Austin, Texas 78748  
Tel. (512) 632-7509  
TBPE Registration Number F-19220